

**DEVELOPMENT OF A COMPUTER-BASED DECISION SUPPORT TOOL
FOR SELECTION OF OPTIMUM TRACTOR-PLOUGH SYSTEM FOR
UPLAND FARMING IN TANZANIA: A CASE OF MVOMERO DISTRICT**

AMON CORNEL MWASANDUBE

**A THESIS SUBMITTED IN FULFILMENT OF THE REQUIREMENTS FOR
THE DEGREE OF DOCTOR OF PHILOSOPHY OF SOKOINE
UNIVERSITY OF AGRICULTURE. MOROGORO, TANZANIA.**

2015

ABSTRACT

In Tanzania, farmers like others elsewhere, have to make informed choices of optimum and cost effective farm machinery. The level, appropriate choice and subsequent proper use of farm machinery has a direct and significant effect on productivity. Tanzanian farmers use traditional intuitive farm machinery selection methods which, in most cases, results in uneconomical investment. The overall objective of this study was to develop a computer-based decision support system tool for selecting optimum tractor-plough systems in Mvomero District. This objective was achieved by initial assessment of the status of agricultural mechanization in the study area. Soil and terrain physical properties including soil bulk density, texture, moisture content, cone index, and slope gradients were determined to form a baseline data for selecting suitable farm machinery. Under the determined soil and terrain characteristics, tractor-plough system's field performance parameters were subsequently determined. Theoretical mathematical models were developed for the simulation of tractor-plough system's static overturning stability limit on slopes. Using SPSS software, regression models were developed to predict the tractor-plough system's field performance and static overturning stability. Employing mathematical models developed in this study and from the literature, a computer-based Tractor-Plough System Selection Tool (TPSST) was developed. The TPSST used procedures and functions from the database to process data entered by users and displayed the least-cost set of tractor-plough system along with other alternative sets. A sample of TPSST output identified a least-cost set of two tractor-plough systems which are capable of completing a 100 ha farm within allotted time. The set comprised of a 74kW tractor/1.25 m plough system and a 31 kW tractor/0.99 m plough system. The simulation output for the 74 kW tractor-plough systems included: 32 kN₀ drawbar pull, 26 kN draught force, 16.5l/h fuel consumption and TZS 3 665 720 total annual cost. The

simulation output for the 31 kW tractor-plough systems was: 12 kN drawbar pull 4 kN, draught force, 6.9 L/h fuel consumption and TZS 1 665 193 total annual cost. It is expected that the TPSST will assist in performing tasks of different agricultural mechanization stakeholders including designers, manufacturers, researchers, trainers, farm machinery managers, extension staff and consultants.

DECLARATION

I, Amon Cornel Mwasandube, do hereby declare to the Senate of Sokoine University of Agriculture that this thesis is my own original work, and that it has neither been submitted nor concurrently being submitted to any other university.

Amon Cornel Mwasandube**PhD Candidate**

Date

The above declaration is confirmed.

Prof. Z. M. Mganilwa**Main Supervisor**

Date

Prof. S.M. Mpanduji**Co-Supervisor**

Date

Prof. D. N. Kimaro**Co-Supervisor**

Date

COPYRIGHT

All rights reserved. No part of this thesis may be reproduced, stored in any retrieval system, or transmitted in any form or by any means, electronic, mechanical, photocopying, recording or otherwise without prior written permission of the author or Sokoine University of Agriculture in that behalf.

ACKNOWLEDGEMENTS

This thesis is the result of a study carried out in Mvomero District in Morogoro region, Tanzania. The success of this work was made possible by moral and material support of different persons and institutions. First, and foremost, I thank the almighty God for providing me with the courage, strength, guidance, patience and passion throughout my study period, for I understand without him I could not have been able to accomplish this study.

I would like to express my sincere appreciation to the Management of the National Institute of Transport (NIT) for enabling and financing my studies in the Department of Agricultural Engineering and Land Planning of Sokoine University of Agriculture. Special thanks are directed to the then top management members: Dr. A. M. Rashid (Principal), Mr. E. Mgonja (Deputy Principal–Academics, Research and Consultancy) and Mr. E Msonge (Deputy Principal- Finance and Administration), for their moral and financial support.

Special thanks are directed to my Supervisors Prof. Z. M. Mganilwa, Prof. S. M. Mpanduji and Prof. D. N. Kimaro, for their tireless guidance, wise advice and constructive criticism. Without them my academic dreams and aspirations would have not become a reality.

I am indebted to Prof. A. K. P. R. Tarimo for his guidance and moral support during my study. I am extending my sincere thanks to all academic members of staff of the Department of Agricultural Engineering and Land Planning, for their material and moral support, advice and for creating a harmonious environment during my stay at the University. I am also extending my sincere thanks to the Centre for Agricultural

Mechanization and Rural Technology (CAMARTEC) for providing test equipment and support staff.

I am also grateful to the farmers (respondents), extension engineer Mr. Felix Temu and other Mvomero District Council staff including District Agricultural and Livestock Development Officer (DALDO) and extension officers for their support during data collection. I am also extending my sincere thanks to Mr. Issaya M. Mwansasu (National Institute of Transport) and King George Magaga (INFOSYS LTD) for their support during computer programming work.

I express my sincere appreciation to my lovely wife Juster Kemilembe Mwasandube and my children Lisa, Merina and Richard for their moral and material support, patience and encouragement which in one way or another made my study successful.

Also, I am very grateful to my brothers: Mr. Alley C. Mwakibolwa, P. Mwasandube, Asukenye Mwasandube, my son in-law Daudi Mbugulu, my in-laws T. Kalinjuna and G. A. Kalinjuna for their moral support and encouragement. It is not easy to mention all who contributed in one way or another in making this work done but I say to you all thank you very much. Let the Almighty God grant you all with his glory, peace and blessings.

DEDICATION

This valuable work is dedicated to my beloved parents the late Mr. H. T. Mwasandube and the late Mrs. S. Mwasandube who raised me with all their love and tenderness during my childhood. This work is also dedicated to my lovely Grandmother the late Mrs. Mbusye Mwakibolwa, and my uncle the late Cornelius Leonard Mwakibolwa who raised me and laid down the foundation of my education which made me what I am today.

TABLE OF CONTENTS

ABSTRACT	ii
DECLARATION	iv
COPYRIGHT	v
ACKNOWLEDGEMENTS	vi
DEDICATION	viii
TABLE OF CONTENTS	ix
LIST OF TABLES	xvii
LIST OF FIGURES	xix
LIST OF APPENDICES	xxii
LIST OF ABBREVIATIONS	xxiv
CHAPTER ONE	1
1.0 INTRODUCTION	1
1.1 Background Information	1
1.2 Problem Statement	2
1.2.1 The role of tractors in agricultural mechanization in Tanzania	2
1.2.2 Selection of farm tractors and equipment	3
1.3 Justification	8
1.4 Objectives	13
1.4.1 Overall objective	13
1.4.2 Specific objectives	13
1.5 Conceptual Model	14
CHAPTER TWO	15
2.0 LITERATURE REVIEW	15

2.1	Analysis of the Status of Agricultural Mechanization.....	15
2.1.1	The status of agricultural mechanization in Tanzania	18
2.1.1.1	Agricultural mechanization in Mvomero District.....	19
2.2	The influence of soil physical properties on field performance of tractor- implement systems.....	20
2.2.1	Soil characterization for traction modelling	21
2.2.1.1	The bevameter technique for soil characterization	22
2.2.1.2	Shear stress - deformation characteristic for soil.....	22
2.2.1.3	The cone penetrometer technique for soil characterization	24
2.3	Modelling of Field Performance of Tractor - Implement Systems.....	26
2.3.1	Theoretical methods for traction performance modelling	27
2.3.2	Empirical methods for traction performance modelling.....	28
2.3.3	Empirical prediction of implement draught force.....	32
2.3.4	Prediction of fuel consumption of farm machinery	35
2.4	The Influence of Land Topography on Agricultural Mechanization.....	35
2.4.1	Characterization of sloping terrain topography	36
2.4.2	Analysis of tractor dynamics and stability on sloping land	36
2.4.3	Determination of stability of tractor-implement system on slopes.....	39
2.5	Farm Machinery Cost Analysis	51
2.5.1	Types of costs	52
2.6	Selection of Farm Tractors and Equipment	55
2.6.1	Previous models for selection of tractors and implements	56
2.6.2	Summary.....	59
	CHAPTER THREE	60
	3.0 MATERIALS AND METHODS	60

3.1	Description of the Study Area.....	60
3.2	Research Design	61
3.2.1	Study population	62
3.2.2	Sample size determination and sampling techniques.....	62
3.3	Data Collection	64
3.3.1	Collection of agricultural mechanization data	64
3.3.1.1	Collection of primary data	64
3.3.1.2	Collection of secondary data.....	65
3.3.2	Determining soil physical properties and terrain gradients in the study area	67
3.3.2.1	Introduction.....	67
3.3.2.2	Determination of soil bulk density, texture and moisture content.....	67
3.3.2.3	Determining of soil cone index.....	68
3.3.2.4	Determination of terrain gradients	69
3.3.3	Determining field performance parameters of tractor-plough system.....	70
3.3.3.1	Introduction.....	70
3.3.3.2	Determining implement draught force.....	71
3.3.3.3	Determination of rolling resistance.....	72
3.3.3.4	Determination of wheel slip.....	72
3.3.3.5	Determining field capacity of tractor-plough system	73
3.3.3.6	Determining fuel consumption	74
3.3.3.7	Determination of field efficiency.....	75
3.4	Data Analysis	75
3.4.1	Statistical analysis of agricultural mechanization data	75
3.4.2	Determining agricultural mechanization status	76

3.4.2.1	Calculation of degree of mechanization	76
3.4.2.2	Calculation of level of mechanization	77
3.4.2.3	Calculation of mechanization index	77
3.4.3	Statistical analysis of soil characteristics data	78
3.4.4	Statistical analysis of field performance data of tractor-plough system	78
3.4.5	Developing regression models for predicting tractor-plough system's field performance parameters.....	79
3.4.5.1	Introduction.....	79
3.4.5.2	Regression models for predicting draught power	79
3.4.5.3	Regression models for predicting fuel consumption	80
CHAPTER FOUR		82
4.0 DEVELOPMENT OF SIMULATION MODELS FOR PREDICTING STATIC STABILITY OF TRACTOR–PLOUGH SYSTEM ON SLOPING TERRAIN		82
4.1	Introduction.....	82
4.2	Developing Simulation Model for Predicting Rearwards Static Overturning Stability of Tractor-Plough System in Uphill Steady Motion	83
4.2.1	Modelling the influence of design parameters on rearwards static stability of tractor –plough system.....	85
4.3	Developing Simulation Model for Predicting Sideways Static Overturning Stability of Tractor-Plough System Operated Across the Slope.....	86
4.3.1	Modelling the influence of design features on sideways static overturning stability of tractor –plough system.....	87

4.4	Developing Simulation Model for Predicting the Overall Static Overturning Stability of Tractor-Plough System on Slope	88
4.5	Simulation of Effects of Design Parameters on Static Overturning Stability of Tractor-Plough System	88
4.5.1	Determining centre of gravity of tractor and plough	89
4.5.2	Simulation algorithm	90
4.5.3	Testing tractors for slope capability in the study area	91
4.6	Developing regression models for predicting tractor-plough system's static overturning stability	91
4.6.1	Introduction	91
4.6.2	Regression models for predicting rearwards static overturning stability of tractor-plough system	92
4.6.3	Regression model for predicting sideways static overturning stability	94
4.6.4	Regression analysis of effects of design parameters on static stability of tractor-plough system	94
4.7	Developing a Computer Decision Support Tool for Selecting Optimum Tractor-Plough System	95
4.7.1	Introduction	95
4.7.2	Establishing equations and algorithm for computer program development	96
4.7.2.1	Equations used for computer program development	96
4.7.3	Computer program development	99
4.7.3.1	Introduction	99
4.7.3.2	Program Modularization	107
4.7.3.3	Creating procedures and functions	108

4.7.4	Program testing	108
4.7.5	Program validation.....	108
5.0	RESULTS AND DISCUSSIONS	110
5.1	Introduction.....	110
5.2	The Status of Farm Mechanization in the Study Area.....	110
5.2.1	Study population characteristics	110
5.2.2	Utilization of farm tractors and equipment in the study area.....	113
5.3	Soil and Terrain Characteristics in the Study Area.....	123
5.4	Tractor-Plough System’s Field Performance Parameters in the Study Area.....	125
5.5	Multiple Regression Models for Predicting Tractor-Plough System’s Field Performance Parameters in the Study Area	127
5.5.1	Introduction.....	127
5.5.2	Regression models for predicting draught power	128
5.5.3	Multiple linear regression models for predicting fuel consumption.....	131
5.6	Static Overturning Stability Limits of Tractor–Plough Systems.....	133
5.6.1	Introduction.....	133
5.6.2	Effects of design parameters on rearwards static overturning stability limits	134
5.6.3	Effects of design parameters on sideways static overturning stability limits	135
5.6.4	Rearwards and sideways static overturning stability limits for sampled tractor-plough systems.....	136
5.6.5	Multiple Linear regression models for predicting rearwards static overturning stability limit of tractor-plough systems	138
5.6.6	Multiple regression models for predicting sideways static overturning stability limit of tractor-plough system	140

5.6.7	Regression models for predicting the effect of design parameters on static stability of tractor-plough system	142
5.6.7.1	Introduction.....	142
5.6.7.2	Regression models for predicting the influence of weight of plough on rearwards static overturning stability.....	142
5.6.7.3	Regression models for predicting influence of horizontal dimension from rear axle to the centre of gravity of plough	144
5.6.7.4	Regression models for predicting influence of horizontal dimension from rear axle to the centre of gravity of tractor	145
5.6.7.5	Regression models for predicting influence of height of the centre of gravity of tractor	146
5.6.7.6	Regression models for predicting the influence of height of the centre of gravity of mounted plough	148
5.7	The Computer-Based Tractor-Plough System Selection Tool	149
5.7.1	Introduction.....	149
5.7.2	TPSST program description.....	149
5.7.3	TPSST validity.....	158
5.7.4	Application of TPSST to select optimum tractor-plough system	159
CHAPTER SIX.....		163
6.0 CONCLUSION AND RECOMMENDATIONS.....		163
6.1	Introduction.....	163
6.2	Conclusion	163

6.2.1	The status of agricultural mechanization in the Study area	163
6.2.2	Soil physical properties, terrain gradients and related field performance parameters of tractor-plough system	165
6.2.3	Mathematical models for predicting field performance parameters and static overturning stability limits of tractor-plough system	166
6.2.3.1	Regression models for predicting draught power	166
6.2.3.2	Linear regression models for predicting fuel consumption	167
6.2.3.3	Linear regression models for predicting rearwards static overturning stability limit of tractor-plough systems	169
6.2.3.4	Multiple regression models for predicting sideways static overturning stability limit of tractor-plough system	170
6.2.3.5	Curve estimation between design parameter and rearwards static overturning stability limit of tractor-plough system.....	170
6.2.4	The Computer-Based Tractor-Plough System Selection Tool	173
6.3	Recommendations.....	174
REFERENCES		176
APPENDICES		191

LIST OF TABLES

Table 1:	Approximate cone index values for different conditions.....	26
Table 2:	Respondents' highest level of education attained	111
Table 4:	Gender	111
Table 5:	Respondents' source of finance for farming operations	112
Table 6:	Diversity of income generating activities	112
Table 7:	Total farm land owned	113
Table 8:	Total cultivated farm land	114
Table 9:	Total available rated power.....	114
Table 10:	Overall condition of tractors	115
Table 11:	Type and number of tractor-operated implements.....	115
Table 12:	Total number of owned tractor-operated implements	116
Table 13:	Average tractor field capacity	117
Table 14:	Mechanism for farm machinery acquisition	117
Table 15:	The most preferred make of tractor	118
Table 16:	The most preferred size (power) of tractor	119
Table 17:	Criterion that is given first priority in choosing a tractor	119
Table 18:	Mechanization degree	120
Table 19:	Mechanization index	121
Table 20:	Estimate of energy used from each source	122
Table 21:	Soil and terrain physical properties	124
Table 22:	Statistics of soil physical properties.....	125
Table 23:	Tractor-plough system's field performance parameters	126
Table 24:	Descriptive statistics of tractor-plough system's field performance parameters	127

Table 25:	Predictors influencing the draft power.....	130
Table 26:	Predictors influencing the fuel consumption	131
Table 27:	Simulated effects of design parameters on rearwards static overturning stability limits	134
Table 28:	Effects of design parameters on sideways static overturning stability limits	136
Table 29:	Rearwards and sideways static overturning stability limits for sampled tractor-plough systems	137
Table 30:	Test results for slope capability of twenty tractors	138
Table 31:	Predictors influencing the rearwards stability index.....	139
Table 32:	Predictors influencing the sideways stability index.....	141
Table 33:	Test statistic, t of observed and predicted tractor power	159
Table 34:	Performance parameters predicted for the selected stable and least-cost set of farm machinery	162

LIST OF FIGURES

Figure 1: Factors influencing the selection of farm machinery	4
Figure 2: Conceptual model of the study.....	14
Figure 3: Schematic layout of a bevameter.....	23
Figure 4: Cone penetrometer.	24
Figure 5: Cone penetrometer for measurement of soil cone index.	25
Figure 6: Challenges related to tractor dynamics and stability.....	37
Figure 7: Six degrees of freedom of a tractor and tipping axes in a sideways overturn	39
Figure 8: Dynamic model of a tractor-mounted implement combination	41
Figure 9: Stability regions for a tractor-mounted implement combination	42
Figure 10: Operating parameters for tractor on slope with impending instability.....	43
Figure 11: Schematic of representation of forces acting on tractor-trailer system.....	45
Figure 12: External forces acting upon a tractor-loader system descending downhill a slope	47
Figure 13: Forces acting on the tractor- forklift system operating on sloping road	49
Figure 14: Forces acting on the tractor - loader system when moving across the slope	51
Figure 15: Map of the study area with located test plots.....	61
Figure 16: Forces acting on tractor-plough system in uphill steady motion.....	84
Figure 17: Forces acting on tractor-plough system in transport position - motion across the slope.....	86
Figure 18: Flow chart of static stability simulation program.....	93
Figure 19: Structure diagram for the tractor - plough system selection tool.	99
Figure 20: Flow diagram of tractor and plough selection program.	100
Figure 21: Pseudo code for selecting optimum tractor-plough system.....	101

Figure 22: Flow chart A for selection of optimum tractor-plough system.	102
Figure 23: Flow chart B for selection of optimum tractor-plough system.	103
Figure 24: Flow chart C for selection of optimum tractor-plough system.	104
Figure 25: Flow chart D for selection of optimum tractor-plough system.	105
Figure 26: Flow chart E for selection of optimum tractor-plough system.....	106
Figure 27: Steps in developing an object-based program	107
Figure 28: Fitted curves of maximum operating slope angles (β) against Weight of plough (kN).....	143
Figure 29: Maximum operating slope angles (β) Vs Horizontal dimension from rear axle to centre of gravity of mounted plough	145
Figure 30: Fitted curve of maximum operating slope angles (β) vs horizontal distance from rear axle to centre of gravity of tractor.....	146
Figure 31: Maximum operating slope angles (β) Vs Height of the centre of gravity of tractor.....	147
Figure 32 Maximum operating slope angles (β) Vs Height of the centre of gravity of plough.	148
Figure 33: Screen for login.	150
Figure 34: TPSST main menu.....	150
Figure 35: Edit/View Window for tractor specifications database.....	151
Figure 36: Edit/View window for disc plough specifications database.....	152
Figure 37: Edit/View window for tyre specifications database	153
Figure 38: Edit/View Window for Tractor's Traction Coefficients.	154
Figure 39: Input window for tractor performance prediction.	155
Figure 40: Window for displaying traction performance prediction results.....	156
Figure 41: Data input window for selection of optimum tractor - plough systems.	157
Figure 42: Window for display of tractor and plough selection results.....	158

Figure 43: Tractor-plough system's selection results.*160

LIST OF APPENDICES

Appendix 1: Test plot No. 1- Wami Luhindo	191
Appendix 2: Test plot No.2- Dakawa Mnadani	192
Appendix 3: Test plot No.3- Milama	193
Appendix 4: Test plot No. 4-Mvomero I.....	194
Appendix 6: Test plot No. 6-Mvomero III.....	196
Appendix 7: Test plot No. 7- Hembeti	197
Appendix 8: Test plot No. 8 –Mkindo	198
Appendix 9: Table of input data and predicted field performance	199
Appendix 10: Table of simulation results	200
Appendix 11: Table of simulation results	201
Appendix 12: Simulation results	202
Appendix 13: Simulation results	203
Appendix 16: Table of draught animals and implements by region	206
Appendix 17: Table of sources of power for different farm activities among small scale farmers	206
Appendix 18: Questionnaire for tractor-owners.....	207
Appendix 19: Questionnaire for non – mechanized farmer	213
Appendix 20: Questionnaire for extension workers.....	214
Appendix 21: Questionnaire for tractor operators.....	215
Appendix 22: Questionnaire for farm machinery dealers/service providers.....	216
Appendix 23: Site marking out before field tests.....	218
Appendix 24: Progressing with tractor field performance tests.....	219
Appendix 25: Counting and timing ten wheel revolutions for wheel slip test.....	220
Appendix 26: Close supervision of tractor field performance tests.....	221

Appendix 27: Measurement of width and depth of cut	222
Appendix 28: Tractor – plough system setting before tests	223
Appendix 29: Measurement of implement draught force (side view)	224
Appendix 31: Attaching a dynamometer to the towed tractor	226
Appendix 32: Determination of field capacity and fuel consumption	227
Appendix 33: Table A of farm tractors in Mvomero District	228
Appendix 34: Table B of farm tractors in Mvomero District	229
Appendix 35: Table C of farm tractors in Mvomero District	230
Appendix 36: Table D of farm tractors in Mvomero District	231
Appendix 37: Table E of farm tractors in Mvomero District.....	232
Appendix 39: Table of draught animals and equipment in Mvomero District	233
Appendix 40: Table of farm power utilization pattern in Mvomero District.....	234
Appendix 41: Table of disc plough specifications and price	234
Appendix 42: Table of specifications and prices of twenty farm tractors	235
Appendix 43: Table of annual fixed costs in percent of list price by machine category and age	236

LIST OF ABBREVIATIONS

2WD	Two Wheel Drive
AEZs	Agro -Ecological Zones
AMIS	Agricultural Mechanization Industrial Strategy
AMS	Agricultural Mechanization Strategy
ASABE	American Society of Agricultural Biological Engineers
ASAE	American Society of Agricultural Engineers
ASTM	American Standards for Testing Materials
Bn	Braxius number
CAMARTEC	Centre for Agricultural Mechanization and Rural Technology
CI	Cone Index
CPa	Actual Field Capacity
CPT	Theoretical Field Capacity
CPT	Cone Penetrometer Test
DALDO	District Agricultural and Livestock Development Officer
DST	Decision Support Tool
EGM	Experts Group Meeting
FAO	Food and Agriculture Organization of the United Nations
Fc	Field capacity
Fe	Field efficiency
GIS	Geographical Information System
GPS	Geographical Positioning System
GTR	Gross Traction Ratio
GUI	Graphical User Interface
Ha	Hectare

IDE	Integrated Development Environment
IFAD	International Fund for Agricultural Development
ISO	International Standard Organization
kN	Kilo Newton
LTD	Limited
MAFC	Ministry of Agriculture, Food Security and Cooperatives
MC	Moisture Contents
MDC	Mvomero District Council
MRR	Motion Resistance Ratio
N	Newton
NTTL	Nebraska Tractor Tests Laboratory
NH-75HP	New Holland -75 Horse Power
NH-90HP	New Holland - 90 Horse Power
NIT	National Institute of Transport
NT	Net Traction
NTR	Net Traction Ratio
OECD	Organization for Economic Cooperation and Development
OSOSI	Overall Static Overturning Stability Index
OSOSL	Overall Static Overturning Stability Limit
PTO	Power Take Off
Qave	Average Fuel Consumption
RSOSI	Rearwards Static Overturning Stability Index
RSOSL	Rearwards Static Overturning Stability Limit
SPSS	Statistical Package for Social Sciences
SSOSI	Sideways Static Overturning Stability Index
SSOSL	Sideways Static Overturning Stability Limit

SVFC	Specific Volumetric Fuel Consumption
TAMS	Tanzania Agricultural Mechanization Strategy
TE	Traction Efficiency
TPSST	Tractor-Plough System Selection Tool
TZS	Tanzanian Shilling
UNAPCAEM	United Nations Asian and Pacific Centre for Agricultural Engineering and Machinery
UNIDO	United Nation Industrial Development Organization
URT	United Republic of Tanzania
VB	Visual Basic
VB6	Visual Basic 6
VIF	Variance Inflation Factor

CHAPTER ONE

1.0 INTRODUCTION

1.1 Background Information

The contribution of agricultural mechanization in enhancing agricultural production and productivity has been well recognized world-wide. According to Liljendahl *et al.* (1997) mechanization of agriculture has several objectives: (i) to increase the productivity per agricultural worker, (ii) to change the character of farm work, making it less arduous and more attractive and (iii) to improve the quality of field operations providing better soil environment for seed germination and plant growth.

Shetto (2004) defined agricultural mechanization as the manufacturing, distribution and operation of all types of tools, implements, machines and equipment for agricultural land development, farm production, crop harvesting, storage and primary processing. Vatsa and Saraswat (2008) stated that mechanization plays an essential role in agriculture and assures timely completion of farm operations as well as less cost per unit area. The end objective of farm mechanization is to enhance the overall productivity and production with the lowest cost of production.

Tanzania is a large country with land resource of 44 million hectares suitable for agricultural production within the seven agro-ecological zones which, according to De Puaw (1984) and URT (2006), they have different soil types, topography, cropping patterns, and scale of farming, timeliness requirements and time available for field operations. Such differences in topography and climate require different mechanization approaches and technologies (URT, 2006). The quality of inputs of mechanization, and consequently land and labour productivity in these agro-ecological zones, may differ

considerably. According to Singh (2006), mechanization technology is location-specific and dynamic.

1.2 Problem Statement

1.2.1 The role of tractors in agricultural mechanization in Tanzania

The agricultural tractor plays an important role in agricultural mechanization as it is widely used for farm operations providing power for driving and control of a range of attached implements and machines. Despite the importance of tractors in mechanization, the level of tractorization in the country is very low with the hand hoe dominating in most farming systems (URT, 2006). According to Shetto (2004) and URT (2006), the average area cultivated by using the hand hoe, animal draught and tractor power is 62%, 24% and 14% respectively.

A study conducted by URT (2006) showed that in year 2006, there were about 13 200 farm tractors (6 000 broken down but repairable), over 14 million hand hoes in use, 585 244 animal-drawn ploughs, 1 307 655 oxen and 81 959 donkeys. It was also reported that tractors are more extensively used in Morogoro, Arusha, Kilimanjaro, Manyara, Dodoma, Shinyanga, Iringa, Mbeya, Mwanza and Tanga regions (Appendices 15 and 16).

One of the identified major mechanization constraints in Tanzania is that its agriculture is dominated by scattered smallholder farmers who cultivate 85% of the total arable land (10.1 million ha) working between 0.2 and 2.0 ha with an average per capita holding of only 0.2 ha per household (URT, 2001).

1.2.2 Selection of farm tractors and equipment

Selecting proper size of farm tractors and equipment to permit economic production in farms is of paramount importance. Improper choice and utilization of farm tractors and equipment practiced by farmers in the country have been attributed to many inhibiting factors. Some of the factors identified by Shetto (2004) and URT (2006) include: (i) inadequate mechanization extension services (ii) poor general technical know-how, (iii) low purchasing power of most small scale farmers, (iv) lack of mechanization credit (v) poor quality of imported farm tractors and implements (vi) lack of awareness and knowledge about the influence of soil characteristics on mechanization in their respective area, (vii) the diversity in the makes, types, and sizes of tractors and implements offered in the market (viii) high prices of spare parts (ix) poorly trained operators and mechanics (x) lack of well-equipped workshops to carry out repair services and (xi) unavailability of some suitable machinery packages for main farm operations.

Planning and selection of optimum farm tractor-implement is a complex process as it involves a number of factors including field performance parameters and other technical and socio-economic factors such as those stipulated above and illustrated in Fig. 1 (Aybek and Boz, 2006). The complexity is mainly due to a compromise that has to be reached among many factors and the intricacy in the analysis of dynamics and stability behaviour of tractor-implement system as well as the prediction of soil-tyre and tractor-soil-implement interactions. Small scale farming and fragmented agricultural holdings in uplands, like in Mgeta and Mlali villages of Mvomero District, face exacerbated difficulties in selection and adoption of appropriate farm machinery technologies (Miyazaki, 2001).

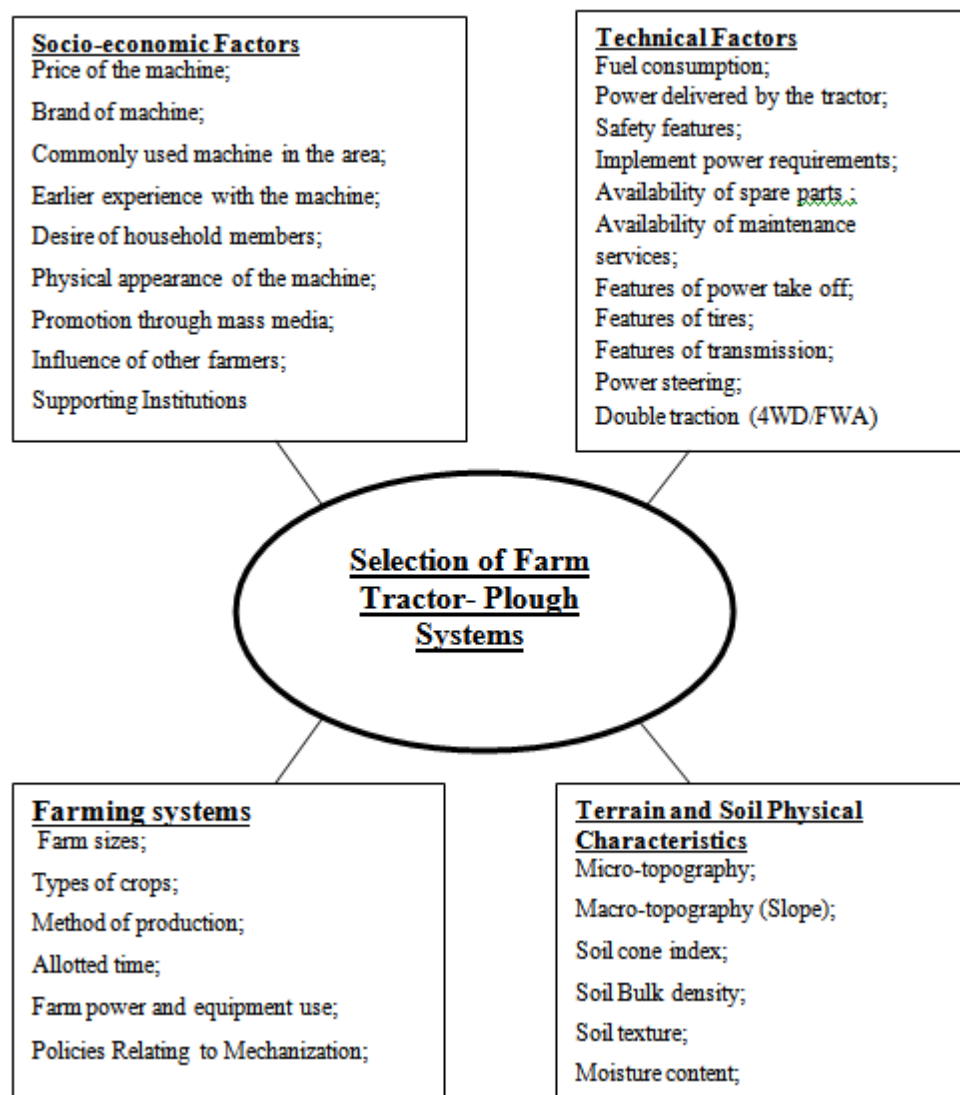

Figure 1: Factors influencing the selection of farm machinery

In an effort to address these constraints, many studies have been conducted world-wide to develop computer-based decision support tools for selection of optimum farm tractors and equipment. The computer-based decision support tools have helped agricultural mechanization practitioners including farm managers to predict draught force and power requirement of tillage implements to determine correctly the proper size of tractor required. A few examples of such decision support tools are those developed by Bol and Mohamed (1997); Grisso *et al.* (2006); Dash and Sirohi (2008); and Vatsa and Saraswat (2008).

Bol and Mohammed (1997) developed a mathematical model to aid decision – makers in selecting optimum farm equipment. The model was based on physical and economic variable optimization method. The model input variables included: fixed cost of the machine, purchase price of a machine, field efficiency of the machine, field speed of the machine, labour cost, tractor use cost, and crop value. Other inputs were: crop yield, timeliness loss factor, scheduling factor, fractional utilization of total time, hours of work per day, and draught per implement width. The model output variables included: optimum size of tractor and implements required to complete the farm operations during a specified time, field time required for a machine to complete an operation, field capacity and fuel consumption. However, the domain of application of this model is limited to the intended real system of interest. This fact effectively limits the use of the model to particular situation for which it was parametrically calibrated and validated. The model focused on addressing the demand for better performance and economical investment in farm machinery. The dynamics and stability behaviour of tractor-implement system on sloping terrain and the demand for operator comfort and greater safety did not receive any attention.

Al-Hamed *et al.* (1990) and Grisso *et al.* (2006) conducted studies to demonstrate the use of spread sheet for selection and matching the tractors of different configurations with different implements or vice versa taking into consideration the terrain conditions, tool width, and operating depth and speed. The spread sheet for predicting the traction performance was based on model developed by Brixius (1987) whereas for the implement draught, prediction was based on the equation published in the Standards of American Society of Agricultural and Biological Engineers, (ASABE) (2006). The prediction output included: drawbar pull, travel speed, drawbar power, power delivery efficiency, vehicle traction ratio, tractor weight to power ratio, fuel consumption. Other

predicted outputs were: draught forces, implement width, actual operating depth, and field capacity. However, the model focused on addressing the demand for better performance. The economic aspects (tractor and equipment costs) were not considered. The dynamics and stability behaviour of tractor-implement system on sloping terrain and demand for operator comfort and greater safety also did not receive any attention. Dash and Sirohi (2008) developed computer-based least-cost model in C programming language for the selection of optimum size of power and equipment system for paddy wheat cropping system. A selection criterion in this model was based on least-cost technique. The input to the model included: area under the crop, soil type, number of operations for each crop, crop rotation and time available for each operation. The model selected the optimum tractor size from amongst the available sizes and its matching implements keeping in view the capacity of machinery to complete the operation in scheduled time for the given farm. The model also computed the working hours and energy requirement for different field operations along with various cost components. The model output was found to be sensitive to various input parameters like farm size, tillage intensity and crop rotation. The model focused on addressing the demand for better performance and economical investment in farm machinery. The disadvantage of this model was its site-specificity. Its validity was defined over the domain of model form, assumptions, inputs, parameters and responses. Another disadvantage is that the dynamics and stability behaviour of tractor-implement system on sloping terrain and demand for operator comfort and safety were not treated accordingly.

The review of the previous farm machinery selection models revealed that majority of the models used tractor power, implement draught power and total annual costs variables as the basic variables for selection of optimum tractor-implement systems. The models focused on addressing the demand for better field performance and economical

investment in farm machinery. The common objective of the models had been to select farm machinery in the size range in which total machinery costs are lowest. Further the literature review has revealed that most of the previous models for selection farm machinery did not give attention to the dynamics and stability behaviour of tractor-implement system on sloping terrain as well as the demand for higher levels of operator comfort and greater safety as important factors for selecting an optimum tractor-implement system.

The analytical mechanics and stability of farm tractors have been studied by several researchers in the past (Liljedahl *et al.*, 1997). Considerable research has been conducted on tractor overturning stability and dynamics on sloping ground (Simion and Nastase, 2009). Yisa *et al.* (1997) suggested that the research into dynamics of tractor and implement systems has to embrace both the demand for human safety factors and better field performance challenges area.

Hazards on slopes are present when a tractor is climbing uphill, travelling downhill, or travelling across the slope (Simion and Nastase, 2009). Determination of the factors influencing the directional stability of a tractor on a slope is connected to establishing safe operating slopes (Gilfillan, 1978). Mathematical models have been developed to analyse the rearwards and sideways stability of tractor–implement systems in the critical situations on sloping land surface. The mathematical models describe the dynamic behaviour of the system under working and transportation situations (Simion and Nastase, 2009). Computer simulation of the dynamics and stability of a tractor-implement system moving up and down sloping ground under different operating conditions are performed to predict the effects of tractor loading, slope angle and tractor design parameters on tractor stability and traction ability (Yisa *et al.*, 1997).

Determining stability of a tractor on a slope has been done in different ways. The test of static stability is based on measuring the weight transfer on a moderate slope and then predicting the slope angle where an uphill wheel will carry no load. The stability of tractor on slope may be expressed in terms of Stability Index (SI) (Ahmadi, 2011). A tractor with a high stability index will be more stable than the one with a low stability index. The stability index is a valuable indicator of tractors which are safer to use on slopes and it can be used to propose maximum operating slope for individual tractors. The stability index provides a standard measure with which the stability of different tractors may be compared. Thus, tractor stability index is an important variable for the development of a tool for selection of suitable tractor-implement systems in the uplands farming systems.

In Tanzania there is no decision support tool for optimizing the selection of tractor-implement systems with respect to stability limit (index), field performance factors and usage costs in the uplands farming systems. Had this decision support tool been available then small scale farmers in uplands could be advised accordingly based on objective factual data that could help them to increase the probability of selecting economical and suitable tractor-plough systems (Mpanduji *et al.*, 2004). This study therefore intends to address some of the mentioned problems.

1.3 Justification

In Tanzania, farmers like others elsewhere have to make informed choices of optimum and cost effective farm tractors and implements. When farm tractors and implements are properly selected, a farmer could ensure safety on slopes and expect reduced power loss,

improved operating efficiency, reduced operating costs, and optimum utilization of capital on fixed costs (Taylor *et al.*, 1991).

Farmers in the country and elsewhere are faced with difficulties in selecting appropriate tractors and equipment. Farmers often use traditional intuitive methods and experience to select tractors and equipment which, in most cases, have resulted in wrong and uneconomical investment (Bol and Mohamed, 1997). Farmers in the country have tendency to prefer big tractors with power greater than 50 kW (67 hp) even in areas where small size tractors may be appropriate. Such subjective preferences may be evidenced from farmers who acquired tractors through agricultural credit program sponsored by the Government (Massawe, 1994). Mpanduji *et al.* (2004) also argued that wrong or subjective decisions related to acquisition and utilization of farm machinery in the country, in most cases, have been caused by lack of required farm machinery management data such as: (i) data indicating the required level of tractor utilization in terms of hours per year or minimum farm sizes required cultivating per year (ii) costs of owning and using tractor and (iii) information on how best the farmer can minimize the costs in Tanzania. This has often caused several drawbacks including higher fixed (ownership) costs and higher operating costs (William, 2002).

Small holder farmers in Mvomero uplands, owning farms with steep gradient, are faced with more challenges in mechanization as they have limited range of suitable farm tractors and implements for selection and adoption due to unfavourable terrain topography and steep slopes (Miyazaki, 2001). In most cases the small and scattered farms are not cost-effective for the application of farm tractors and equipment (Rasouli *et al.*, 2009). This is the reason why agricultural mechanization development in uplands often lagged behind the lowland farming systems (Miyazaki, 2001).

The topography and climate of Mvomero District varies greatly. The altitude of the district is between 380 meters and 1 520 meters above sea level (MOVEK-DSL, 2008). Several villages of Mvomero district are located in mountains and highlands in the northwest and south of the district. Such villages include Hoza, Pemba in the northwest and Mgeta and Mlali in the southeast. The villages, located within altitude of 500-1500 meter above sea level are characterized by undulating to hilly plateau, very strong dissected mountain block with steep to very steep slopes (De Pauw, 1984). There are serious potential risks of accidents and injuries involved while using tractors on such steep terrain as they can either roll over sideways or backward (Spencer and Owen, 1981).

Accidents involving overturning farm tractors are issues of growing concern worldwide (Runyan, 1993; Atanda, 2005 and Rondelli *et al.*, 2013). Farm tractor accidents are estimated to claim many lives annually throughout the world. Of these fatalities, approximately 70% are caused by the tractor either overturning sideways or rearwards (Abubakar *et al.*, 2010).

Most of the reports published on agricultural accidents and injuries have originated from developed countries (Kumar and Dewangan, 2009). In developing countries, including Tanzania, there are few records related to farm accidents as many of the injuries are rarely reported to relevant authorities (Hunter and Owen, 1985). Several studies have associated the increase of tractor accidents to the increased number of tractors (Fargnoli *et al.*, 2010). In Tanzania, tractor importation and use is on the increase due to deliberate government policies to boost food production [www.tradingeconomics.com/tanzania/agricultural/ Site visited on 18 December, 2014].

As in the highly mechanized countries, it is anticipated that this trend will probably have an impact on the increased number of farm tractor accidents in the country.

The existing commercial decision support tools for selecting farm tractors and equipment are potential for adoption and use in Mvomero District situation and environment to address the challenges faced by smallholder farmers. But these models have several disadvantages and limitations. They are either site-specific or too general and comprehensive with a broad application resulting in lower sensitivity. This implies that these tools cannot be wholly adopted for application in Mvomero District without being adapted with some modifications to suit the local situation and environment. There is no tractor-implement stability limits data in place for facilitation of the selection of tractor-plough systems suitable for the upland farming systems in Mvomero District and in the country at large. Thus, more information regarding dynamics and stability behaviour of the tractor-implement system in uplands is needed for adaptation of the existing tools for selection of tractor-implement systems.

The intricacy of the required modifications and the introduction of stability limits as one of the variables for selection of optimum tractor and plough system necessitated the development of a new tool. It is upon these considerations a study was carried out to develop a decision support tool to facilitate better decisions in selecting optimum tractor-plough combinations for the upland farming systems in Mvomero District and other districts of the country which have similar terrain and soil characteristics.

The developed Tractor-Plough System Selection Tool (TPSST) analyses the mechanics of tractor-implement performance and optimized the matching of tractors with implements. It is therefore, expected that the TPSST will assist those who have an

interest in the analysis of the mechanics of tractor - implement performance and selection of farm tractors and equipment.

The tractor designers (manufacturers) wishing to predict whether the tractor and implement being designed will achieve the design objectives. They may employ the TPSST. Manufacturers may also use this tool to improve the tractor performance by comparing and analysing various parameters that influence tractor–implement system’s performance and static stability.

The tool is also expected to help those who are advisers to the farmers including extension advisers, farm machinery dealers and sales persons. They may use the TPSST to understand tractor- implement system’s performance. Their interest is not in design but in how to choose (in economic as well as physical terms) a tractor-plough system from a range available to achieve required work rate. Farmers (tractor users) could use the tool to understand the basic aspects of tractor-implement system selection and field performance prediction so that they may use to interact with their advisers.

It is also expected that the TPSST will assist those who are responsible for providing services such as training, research, consultancy administration, safety and other associated aspects to the farmers (tractor users). They can use the tool to understand the tractor–implement system’s performance and so provide valid and useful advice. In technical education and training especially in agricultural institutions it is anticipated that the tool will play a role as it can help students to better understand the performance and stability aspects of tractor-implement systems in the field. With this tool, students will be able to predict draught and power requirement of tillage implement on different soil and terrain conditions to determine correctly the proper sizes of tractors required while seated

in their class rooms. The tool could also be used by researchers and consultants to predict the field performance factors and to determine the relative importance of factors affecting the performance of tractors without conducting expensive and time consuming field tests.

1.4 Objectives

1.4.1 Overall objective

The overall objective of this study was to develop a computer-based decision support tool for selection of optimum tractor-plough systems for upland farming in Mvomero District.

1.4.2 Specific objectives

The specific objectives were to:

- (i) Analyse the status of agricultural mechanization (in terms of farm machinery choice, acquisition mechanisms and utilization level) in selected villages of Mvomero District.
- (ii) Determine soil physical properties, terrain slopes and related field performance parameters for selection of optimum tractor-plough system in selected villages of Mvomero District.
- (iii) Develop mathematical models for predicting tractor-plough system's field performance parameters and static overturning stability limits with respect to the determined soil and terrain characteristics in the study area.
- (iv) Develop a computer program for selecting optimum tractor-plough system with respect to the field performance parameters, static overturning stability limits and total annual costs.
- (v) Validate the developed computer program.

1.5 Conceptual Model

The Tractor-Plough System Selection Tool (TPSST) comprises of database, mathematical models, and processing software along with default data and user input data. This is a computer-based information system that provides a flexible tool for prediction of performance of tractor-plough systems.

Schematic representations of the considered domain for analysis and selection of tractors and ploughs are shown in Fig. 2. Some features of the TPSST include (i) User Input (ii) Processing (iii) Sub-procedures and Functions section (Models) (iv) Database section and (v) Output section.

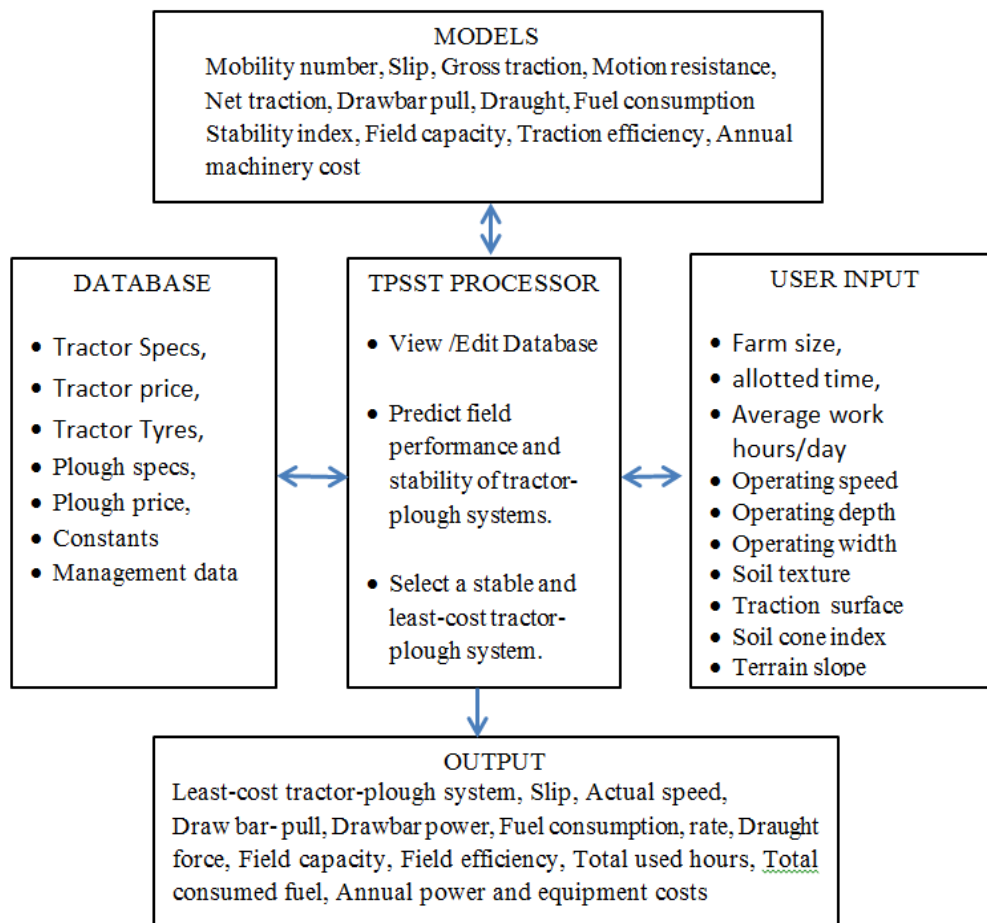

Figure 2: Conceptual model of the study.

CHAPTER TWO

2.0 LITERATURE REVIEW

2.1 Analysis of the Status of Agricultural Mechanization

To formulate sustainable agricultural mechanization strategy at any level, the first step is to analyse the existing farm mechanization situation and define the actions to move from the existing situation to the optimum future situation (FAO, 2010). The precise knowledge of the existing situation and the problems facing the development of agricultural mechanization is a prerequisite requirement for preparation of reliable plan to develop a sustainable agricultural mechanization (Datt, 1988).

Agricultural mechanization situational analysis involves the relevant issues related to application and management of tractors, machines, systems and structures in agricultural production (Clarke (2000). At national level, analysis of the existing farm mechanization situation will include, among others, national inventories, domestic manufacturing and assembly (tools, implements, tractors etc.), importation of farm tools and machinery, as well as descriptions of farming systems in relation to the use of farm power and their respective changes over time (Tilakaratna, 2005 and Unadi, 2012). The activities involved in situational analysis of agricultural mechanization should, according to Clarke (2000), include: (a) Assessment of existing agricultural practices and analysis of supply chains; (b) Analysis of existing policies; (c) Assessment of existing intra- and inter-institutions involved in agricultural mechanization; (d) Assessment and identification of technologies suited to specific ecological zones; and (e) Assessment of the use of targeted subsidies for innovative implements for sustainable farm mechanization.

In many countries worldwide, the situational analyses of the agricultural mechanization sub-sector have been conducted to diagnose the strengths and weaknesses of the sub-sector (Tilakaratna, 2003; FAO/UNIDO, 2008; FAO, 2010; Soni and Ou, 2011). The FAO/UNIDO (2008) convened an Expert Group Meeting (EGM) with the objectives of reviewing the current situation and constraints on agricultural mechanization in Africa and recommended ways through which these constraints could be tackled to support economic growth and poverty reduction.

The EGM recommended, among others, the following actions be put in place to enhance the mechanization inputs in African agriculture: (a) Support and encourage the existing advanced and successful commercial farming sector, (b) Place more emphasis on the development of small-scale farmers particularly in the technical and socio-economic areas, (c) Strengthen input supply networks and promote the manufacturing base on agricultural operations and processing technologies, (d) Promote environmentally friendly mechanization practices that will result in sustainable economic growth, such as no-till and conservation agriculture practices, (e) Provide in-service training for extension officers, artisans and other entrepreneurs to improve technical-knowhow, (f) Develop a comprehensive agricultural mechanization strategy (AMS) and agricultural industry development strategy (AMIS) for the countries at regional level and (g) Make the importation and distribution of farm machinery basically a private-sector function(Tilakaratna, 2003).

FAO (2010) conducted a situation analysis of the agricultural mechanization sub-sector in Mali and Ghana to identify their strengths and weaknesses. The analysis comprised: the preliminary study and diagnostic analysis. The results of the analysis revealed three major problems hampering the development of agricultural mechanization in the

countries. These were: (a) inadequately equipped farmers; (b) difficulties of producers, importers and distributors of agricultural equipment to sell their products; and (c) absence of a coherent agricultural mechanization policy (FAO, 2010).

Using a descriptive approach, Andrade and Jenkins (2003) performed a study of the dynamics of farm mechanization in the agricultural regions in México. The study was aimed at identifying patterns of farm equipment utilization through multivariate analyses of relevant data. Data was collected from farmers along with extension agents and farm machinery dealers through interviews. The methodology used for pattern definition was based on dimensionality reduction through principal component analysis. Several distinct groups of farmers were identified. Each group featured a unique combination of characteristics for which the use of farm equipment was well differentiated. The study also formulated an index to measure the mechanization status achieved at the individual level. The Mechanization Index (MI) elaborated here is an expression of the deviation of the actual amount of motorized farm work from the mean values at the regional level. This index is based on the premise that a mechanized farmer is the one that finds a way to utilize amounts of mechanical energy that are higher than the typical values using locally available technology. Several other indicators of mechanization that are useful at a larger scale (from regional to national) were computed. These include: rated power per unit area, number of tractors per unit area, draught animals per unit area, weight of implements per unit area, number of implements per unit area, realized mechanization potential, and machinery utilization ratio (Vatsa *et al.*, 2009).

Sharabiani and Ranjbar (2008) conducted a study to determine the degree, level and capacity indices for agricultural mechanization in Sarab Region, Iran. The methodology of the study involved the calculation of the number of tractors, types of machines, and

degree, level, and capacity of mechanization. The results showed that the average level of mechanization in the region was 0.83 hp per ha. The energy expenditure per hectare (mechanization capacity) by energy source of human, animal and machine, was 1.24%, 2.23%, and 96.35 % respectively.

A study was conducted by Soni and Ou (2011) to review the economic, social and agricultural development in six Asian countries. It analysed a host of factors that affected agricultural mechanization of the region, including overall level of economic development, migration of rural labour, land utilization, agricultural production, food demand, agricultural machinery industry, trade and manufacturing capacity and testing. The findings pointed out that traditional agricultural techniques and cultivation practices had changed significantly with breakthroughs of science and technology.

2.1.1 The status of agricultural mechanization in Tanzania

In the last decade, several studies were conducted to appraise the status of mechanization in the country. The URT (2006) carried out a study through surveys in all 21 regions with the objective of appraising the status of mechanization as part of the Tanzania Agricultural Mechanization Strategy (TAMS) formulation process. Data was collected from smallholder farmers, large and medium scale farmers as well as other agricultural mechanization and agro processing stake holders.

According to URT (2006) the level of mechanization has remained low with the hand hoe dominating in the farming systems. The use of animal traction and mechanical power is limited. The average area cultivated by using the hand hoe, animal draught and tractor power were reported to be 62%, 24% and 14% respectively (Appendix 17). It was also reported by URT (2006) that in year 2006 there were about 7 200 tractors that

were operational and another 6 000 were broken down although repairable (Appendix 15). It was also reported that there were over 14 million hand hoes in use, about 585 000 animal drawn ploughs and 1 300 000 oxen. The study also reported that on average 2 000 000 hand hoes, 20 000 animal drawn ploughs and between 200 and 300 tractors were imported annually. Furthermore, the report indicated that the country needs between 30 000 to 40 000 animal drawn ploughs and 1 500 to 1,800 tractors annually in order to cater for farm power needs for satisfactory agricultural growth.

The report further showed that tractors are more extensively used in Morogoro, Arusha, Kilimanjaro, Manyara, Dodoma, Shinyanga, Iringa, Mbeya, Mwanza and Tanga regions (Appendix 15), whereas animal traction is more dominant in traditional livestock keeping regions such as Shinyanga, Mara, Singida, Tabora, Mwanza, Manyara, Mbeya, Iringa, Rukwa, Dodoma and Arusha (Appendix 16).

The development of mechanization in the country is hampered by several factors URT (2006). These factors include: low purchasing power of most small scale farmers, low producer prices, high cost of agricultural machinery, lack of agricultural credit, lack of well-trained operators and mechanics for agricultural machinery. Other reported factors include: lack of suitable machinery packages for main agricultural operations, importation of tools and machinery of poor quality, weak private sector and general poor technical know-how.

2.1.1.1 Agricultural mechanization in Mvomero District

The level of mechanization in Mvomero district, like in other districts in the country, has remained low with the hand hoe dominating in the farming systems (Appendix 40). According to the socio-economic development report of Mvomero District Council,

(MDC), (2009), the average area cultivated by using the hand hoe, draught animal and tractor in the district is 70%, 10% and 20% of the total cultivated area of 247 219 hectares respectively.

There are about 187 tractors that are operational and another 25 are broken down although repairable. Most of these tractors are 2WD and dominated by two makes of Fiat and Ford. The number of tractors has increased from about 138 in the 2005/06 to about 174 in 2009/10 (Appendices 33 - 38). Tractors are dominant in the wetland paddy-sugarcane and maize farming systems in the wards of Mtibwa and Mvomero.

Draught animals are also important source of farm power in the district. It is a suitable technology for dominating smallholders in the district whereby non-owners also benefit substantially by accessing the technology through direct hire or through other social arrangements. MDC (2009) reported that in 2009 there were over 71 animal drawn ploughs, 12 weeding machines, 13 ridging machines, 77 trailers, 161 oxen and 162 donkeys (Appendix 39). The number of draught oxen has increased from about 111 in the year 2004 to about 161 in 2008 while the number of draught donkeys has increased from about 50 in the year 2004 to about 162 in 2008 (Appendix 38).

2.2 The influence of soil physical properties on field performance of tractor-implement systems

Agricultural tractors operate under often difficult conditions and requirements (Macmillan, 2002). Such conditions include: (a) agricultural soils which slip when loaded horizontally and compact when loaded vertically; (b) highly variable operating conditions both in time and place; (c) variable loading conditions on the system and (d) rough and sloping topography.

Understanding and predicting of tractor and implement field performance under such conditions has been a major goal of many agricultural mechanization researchers worldwide. The important field performance factors that are influenced by such conditions include traction force, drawbar pull, and implement draught, wheel slip, rolling resistance, fuel consumption and field capacity (Macmillan, 2002).

In tractor traction mechanics the determination of the soil physical properties is one of the fundamental tasks for the prediction and evaluation of traction performance. Performance evaluation of terrain – tractor systems involves both the design parameters for the tractor and the measurement and evaluation of the physical environment within which the tractor operates.

2.2.1 Soil characterization for traction modelling

When the tractor travels over a soft terrain surface, soil strength parameters are the major factors affecting the supporting, floating, shear, friction and other abilities of the soil under the tractor load (Yu, 2006). The prediction of off-road vehicle performance, to large extent, depends on the proper evaluation and measurement of the strength parameters of the terrain which has been one of the major objectives of terrain – vehicle mobility research.

The standard methods for measuring soil strength parameters usually involve laboratory experiments, carried out on relatively small soil samples. In off-road vehicle engineering, if the soil strength and deformation characteristics are to be closely related to the field conditions under which the performance of the vehicles are evaluated, it is necessary to measure soil parameters in the field (in-situ measurement). The techniques currently in use for measuring and characterizing in-situ soil strength properties include the

bevameter (Bekker, 1956) and cone penetrometer (ASAE, 1998). Purely analytical methods, which are not carried out in fields, have not been used extensively for practical applications. Therefore, for the in-situ measurement in the field, the cone bevameter and penetrometer techniques are still the two most frequently used for soil characterization for traction and mobility modelling.

2.2.1.1 The bevameter technique for soil characterization

The bevameter technique, originally developed by Bekker (1956) is well documented for characterizing soil strength and soil sinkage parameters relevant to traction performance. Since a traction device applies both contact pressure and tangential stresses to the terrain surface to develop traction effort, it seems reasonable to simulate the real phenomenon by applying loads in both directions. The bevameter technique consists of: (i) plate sinkage test to determine the pressure – sinkage relationships of soil; and (ii) a shear test to determine the in-situ shear strength parameters of the soil. Complete bevameter is illustrated schematically in Fig. 3.

2.2.1.2 Shear stress - deformation characteristic for soil

To determine the shear strength of the terrain and to predict the traction performance of an off-road vehicle, it is essential to measure the shear stress versus shear displacement relationship under various contact pressure conditions. The shear stress - deformation relationship for soils may take different forms depending on the normal and shear stresses under which they were compacted and their degree of bonding together of the soil particles.

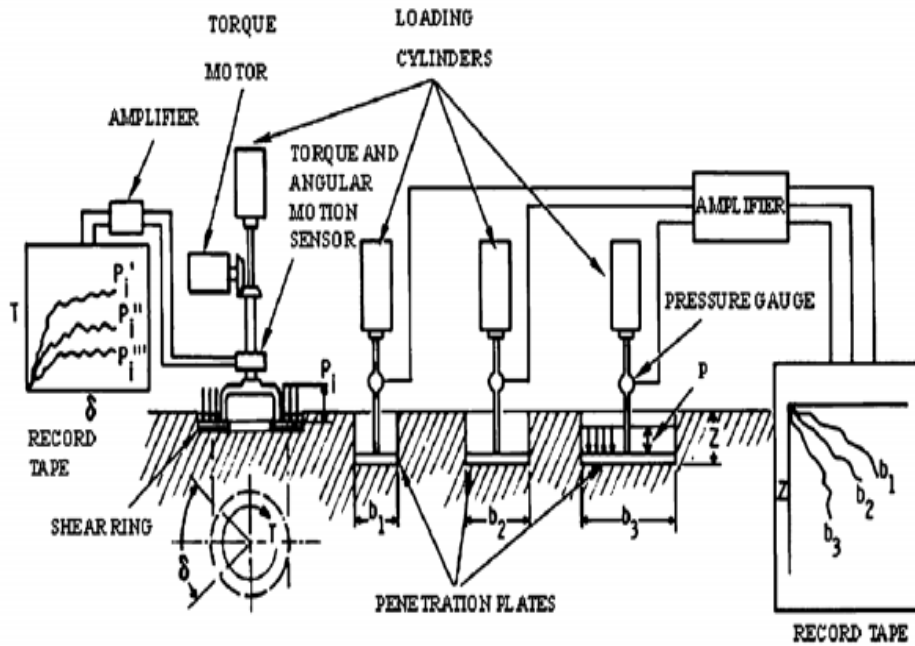

Figure 3: Schematic layout of a bevameter (Wong, 1993).

Bekker (1956) fitted empirical equations to two typical forms and analyzed traction force by integrating them over the length of the track. The soil shear stress- deformation characteristic for such a soil is assumed to have the following form:

$$S = S_{\max} (1 - e^{-j/k}) \quad (1)$$

Where:

$S_{\max} = (c + \sigma \tan \phi)$ = shear strength of the soil and corresponds to shear stress at large deformation

c = soil cohesion

ϕ = angle of internal friction

σ = normal stress

j = shear deformation

k = shear deformation modulus

Hence,

$$S = (c + \sigma \tan \phi) (1 - e^{-j/k}) \quad (2)$$

2.2.1.3 The cone penetrometer technique for soil characterization

To interpret and compare the results, the design and use of cone penetrometer for agricultural applications, according to ASAE (1998), is standardized as ASAE S313.2. The ASAE standard also specifies the index application range for different penetrometer types, penetration speed and depth increments for soil characterization.

The penetrometer consists of a circular 30° stainless cone mounted on a circular stainless steel shaft as shown in Fig.4. Other standardized dimensions of the penetrometer and the components are shown in Fig. 4 and Fig. 5 (a) and (b).

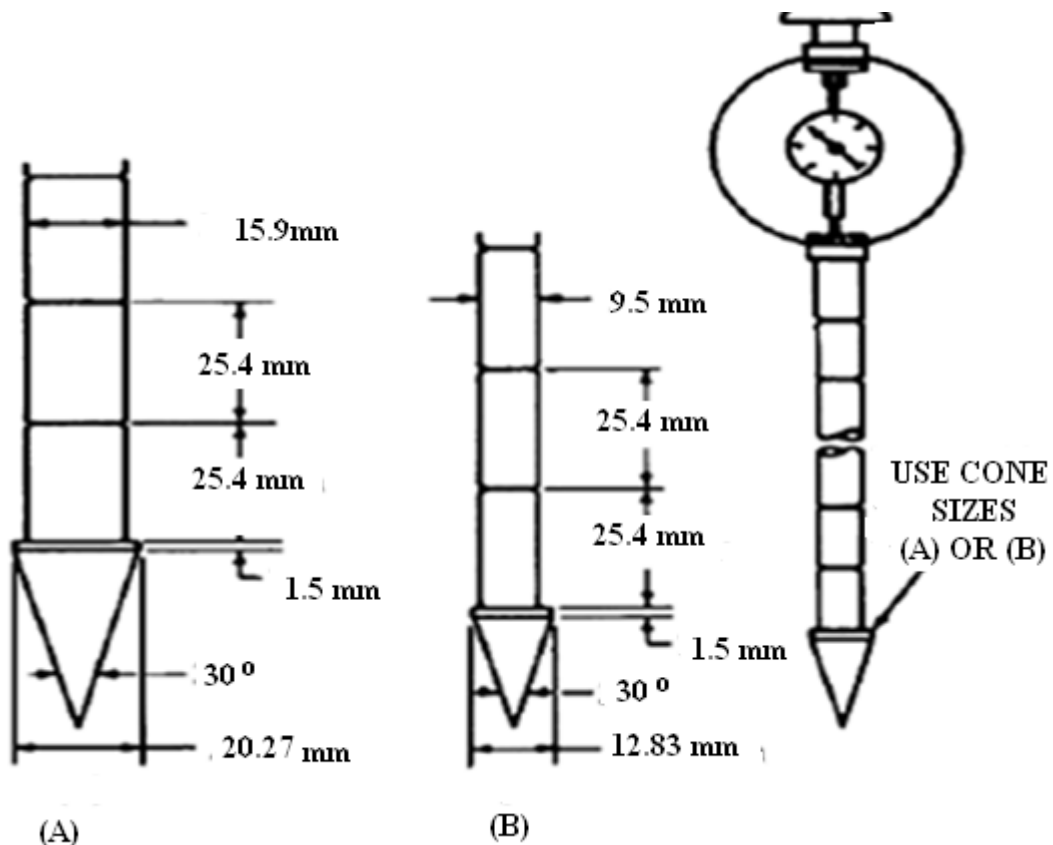

Figure 4: Cone penetrometer (ASAE, 1998).

The value of “Cone Index (CI)” represents the average penetration force per unit projected cone base area exerted by the soil upon the conical head when forced down to a specific depth at a penetration rate of about 3 cm/s as recommended by the ASAE standard S313.2 (ASAE, 1998). The cone index constitutes a compound parameter reflecting the comprehensive influence of shear, compression and even soil–metal friction.

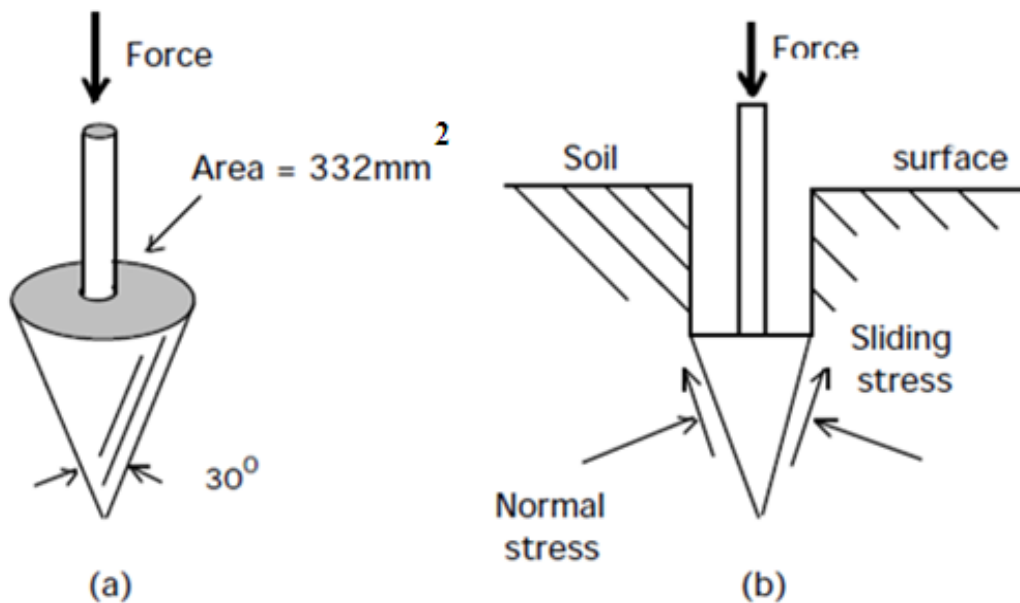

Figure 5: Cone penetrometer for measurement of soil cone index (Macmillan, 2002).

The Cone Index (CI) values may vary considerably with depth (Wisner and Luth, 1973). The CI values usually used for traction prediction are the average values of recorded depth corresponding to the maximum sinkage of traction device of tractor (tyre or track). For many years, the penetration test remained a very popular used method applied by researchers for soil compaction and for some empirical traction studies. However, the Cone Index is not sufficient to replace the soil strength parameters for representing the interaction between the traction device and the terrain surface.

Despite its limitations to interpret the comprehensive soil property, the cone penetrometer with further modification and validation can efficiently be used for traction prediction. The cone penetrometer is perhaps the simplest in-situ method and the most widely used technique. CI is an average cone penetration resistance value at 0.15 m layer. If the penetrometer value is not known, a “standard value” for average conditions can be used as indicated in Table 1.

Table 1: Approximate cone index values for different conditions

MC* (%)	Description	CI (kPa)
>50	Wet depressions, poor bearing capacity	400
35	Moist conditions some kind of limit for forwarder	500
25	Well bearing soil	750
20	Dry bearing soils	1 000
12	Dry, good bearing capacity	1 500
5	Very dry, good bearing capacity	3 000

MC* = Moisture Content
(Source: Macmillan, 2002)

The in-situ measurement methods are preferable to the laboratory methods from the point of view of minimum disturbance of the soil sample. Furthermore, the in-situ methods represent the real soil state in the field better than the samples tested in a laboratory (Yu, 2006).

2.3 Modelling of Field Performance of Tractor - Implement Systems

The traction performance of a tractor depends on the forces developed by the traction device (tyres) to the soil and on the resistance of the soil to them. The important parameters to describe the traction conditions are soil physical properties (soil moisture

content, bulk density, soil texture and soil strength). Tyre parameters including diameter, width, and inflation pressure are also important in describing traction conditions.

The implement draught force and power is directly related to working depth, tool geometry, travel speed, width of implement and soil properties (moisture content, bulk density, cone index and soil texture) (Gee Clough *et al.*, 1978). The availability of data relating to drawbar pull and draught requirement of tillage implements is an important factor in planning and selecting suitable tractors and tillage implements for a particular farm situation (Gee Clough *et al.*, 1978). The computer models and simulation programs help farm managers and consultants to predict draught and power requirement of tillage implements on different soil types and conditions to determine correctly the proper size of tractor required. The studies of tractor and implement field performance on agricultural soils have proceeded along theoretical and empirical approaches.

2.3.1 Theoretical methods for traction performance modelling

According to Liljendahl *et al.* (1997), the theoretical approach for traction modelling uses classical soil properties (cohesion (c) and angle of internal friction (Φ) and some semi-empirical parameters to develop a model for the prediction of the traction force, drawbar pull and implement draught. The early work by Bekker (1956) and later work by Reece (1966) and many others used the standard properties of the soil (cohesion and angle of internal friction) and an empirical deformation parameter to characterize its strength and deformation properties respectively. Based on the parameters measured by the bevameter technique, Bekker originally developed one of the best known and most commonly used analytical methods-also known as a semi-empirical method for traction (Bekker, 1956).

According to Macmillan (2002) the theoretical approach provides a good understanding of the traction processes and the effect of the dimensional characteristics of the wheel and the strength properties of the soil. However, this approach has two difficulties associated with the measurement of the surface properties. They require complex facilities and are likely to be time consuming.

2.3.2 Empirical methods for traction performance modelling

In the empirical prediction of traction performance, only one soil parameter is measured for the prediction of both traction force and rolling resistance (Wismer and Luth, 1972, 1974). This parameter, known as the 'cone index', is not dependent on the measurement of deformation or sinkage as is required in the determination of the respective model in the theoretical approach (Zoz and Grisso, 2003). The approach allows a rapid survey of the area of interest and incidentally reveals the great variability due to the variation in soil texture and the effect of moisture content. The development of the algorithms that constitute the traction model requires an extensive series of measurements of cone index and corresponding tractor performance as reported by Gee-Clough *et al.* (1978) and Parkhill (1986). Wismer and Luth (1972) developed the utility of this approach for predicting traction performance. They outlined a set of equations to predict traction characteristics of pneumatic wheels powered in soils. Later on a soil-tyre numeric (N) was proposed for cohesive –frictional soils by Wismer and Luth (1973) as:

$$N = \frac{CI \cdot b \cdot d}{W} \quad (3)$$

Where:

CI = Cone Index (kPa)

W = Dynamic weight on tyre (kN)

b = Tyre width, (m)

d = Tyre diameter, (m)

The Wismer and Luth equations have practical restrictions on the tyre section width to tyre diameter ratio (b/d), the tyre deflection to tyre section height ratio (δ/h), and the tyre rolling radius to diameter ratio (r/d). The preceding ratios were held constant at values approximately 0.3, 0.20, and 0.475, respectively. This was applied to wheels on agricultural soils as reported by Wismer and Luth (1974) and Dwyer *et al.* (1976). The latter authors used the cone index to calculate a dimensionless, tyre mobility number by Equation 4:

$$M = \frac{CI \cdot b \cdot d}{W} \sqrt{\frac{\delta}{h} \frac{d}{d + 0.5b}} \quad (4)$$

Where

M = mobility number

δ = tyre deflection under the weight W , (m)

The above equation 4 for numeric is the most commonly used empirical relationship to predict traction performance for wheels. The soil-tyre numeric is correlated with three traction performance parameters for tyres. Among the parameters used in this equation, rolling resistance is a parameter often correlated with the soil-tyre numeric.

Wismer and Luth (1974) developed the following generally used equations for not highly compactable soils:

$$\rho = \frac{Rr}{W} \frac{1.2}{N} + 0.04 \quad (5)$$

$$\mu_g = \frac{T}{rW} = \frac{Ft}{W} = 0.75(1 - e^{-0.3Ns}) \quad (6)$$

Where:

- N = $CI.b.d/W$ = wheel numeric,
 R_r = motion resistance (N)
 T = applied torque (Nm)
 r = rolling radius based on a zero condition when net traction is zero at zero slip on a hard surface (m)
 F_t = gross traction force (N)
 μ_g = gross traction coefficient
 ρ = motion resistance ratio
 S = Wheel slip

The wheel pull coefficient or traction coefficient (μ) was calculated from the following equation:

$$\mu = \frac{F_t - R_r}{W} = \mu_g - \rho \quad (7)$$

The pull, torque, and slip characteristics of a driving wheel define both the magnitude and efficiency of traction performance. The traction efficiency (TE) of a wheel is defined as:

$$TE = \frac{u}{\mu_g} (1 - s) \quad (8)$$

Where: u_{gx} and μ are defined in equations 6 and 7 respectively.

Brixius (1987) presented revisions to the Wismer and Luth's equations for bias-ply tires that improved the prediction of traction performance and extended the range of applications. The revised equations can be applied to wheeled vehicles ranging from lawn and garden tractors to earthmovers. The width-to-diameter ratio, deflection ratio, weight

divided by width and diameter, and cone index, are within the applicable limits. The applicable limits of the cone index include all conditions typically encountered by agricultural tractor tyres. Wheel torque, motion resistance, net traction and traction efficiency were predicted as a function of soil strength, wheel load, tyre size, and tyre deflection for both dual and single wheels. Part of gross traction ratio (GTR) overcomes motion resistance ratio (MRR). The net traction ratio (NTR) available from a wheel is defined in the Brixius (1987) equations (ASABE, 2006):

$$B_n = \left(\frac{C_1 \cdot b \cdot d}{w} \right) \cdot \left\{ \frac{1 + K_1 \cdot \left(\frac{\delta}{h} \right)}{1 + K_2 \cdot \left(\frac{b}{d} \right)} \right\} \quad (9)$$

$$GTR = \frac{T}{rW} = C_1 \cdot \{1 - e^{-c_2 B_n}\} \cdot \{1 - e^{-C_3 s}\} + C_4 \quad (10)$$

$$MRR = \frac{M}{W} = \frac{C_5}{B_n} + C_4 + \frac{C_6 \cdot s}{\sqrt{B_n}} \quad (11)$$

$$NTR = \frac{NT}{W} = GTR - MRR \quad (12)$$

Where:

- B_n = Mobility number;
- GTR = Gross traction ratio;
- MRR = Motion resistance ratio;
- NTR = Net traction ratio
- b = Unloaded tyre section width;
- r = Tyre rolling radius;
- h = Tyre section height;
- s = Wheel slip;
- NT = Net traction or pull;
- T = Axle torque;

- CI = Cone index;
- d = Unloaded tyre diameter;
- δ = the tyre deflection;
- W = the dynamic load on the traction devices;
- K1 and K2 = constants (Values depend on the type of tyres);
- C1, C2, C3, C4, C5, and C6 = coefficients.

2.3.3 Empirical prediction of implement draught force

Draught is defined as the force required for pulling an implement in the horizontal direction of travel. Many studies have been conducted to measure draught and power requirements of tillage implements operating on various soil conditions. Mathematical models have also been developed by researchers to predict draught and power requirements of tillage implements. Prediction of forces on ploughs received more attention at the beginning of 1970s. To predict the draught forces, Larson *et al.* (1968) used several models of ploughs of similar shapes but different dimensions and made field experiments in different soils. The procedure was based on dimensional analysis. From their experimental data and the pi terms of their equation, they concluded that, cohesion and angle of shearing resistance were the main soil parameters influencing draught forces on the plough.

Gee-Clough *et al.* (1978) developed an empirical equation to predict the draught forces on the basis of dimensional analysis. The equation obtained included depth and width of cut, soil specific weight, ploughing speed and the gravitational constant.

Investigations in a soil bin to determine soil parameters pertinent for the prediction of the draught of a model plough were made by Kuczewski (1981). The empirical model

developed showed that the contribution of shearing parameter to the resulting force was insignificant. According to him this might be due to the soil conditions used during the experiments.

Oskoui and Witney (1982) developed empirical equations to describe the plough using the soil cone index and ploughing speed. The soil cone index was used to represent soil moisture content and specific weight. The mouldboard tail angle was involved in their equation to represent the plough geometry.

Gao-Qiong *et al.* (1986) developed a model to predict soil forces on the mould board plough taking velocities of a soil block along the mouldboard plough surface, soil internal stress, ploughing depth and speed, coefficient of soil-metal friction as the main parameters in the model. They reported that the difference between the predicted and measured forces was within the range of 10 per cent. The draught required to pull a tillage implement is basically a function of implement width, operating depth, and the speed at which it is pulled. The draught forces on implements increase significantly with speed and the relationship varies from linear to quadratic. Draught also depends on soil conditions and geometry of the tillage implements (Upadhyaya *et al.*, 1984).

Harrigan and Rotz (1994) proposed a simple function for a range of soil conditions and machine specific parameters to predict the draught of tillage and seeding implements under general conditions. Their findings indicated that the draught per unit width or cross-sectional area of the tilled zone is a function of soil type and the speed at which the implement is pulled. They presented reference tables for soil and machine specific parameters. These tables and mathematical expressions were adopted by the American Society of Agricultural Engineers to revise the ASAE Standards for Agricultural

Machinery Management Data as part of ASAE D497.4 standard to predict draught requirements for tillage implements in several soil types (ASAE, 2003).

For seeding implements and minor tillage tools operated at shallow depths, draught is primarily a function of the implement width and the speed at which it is pulled. For tillage tools operated at deeper depths, draught also depends upon soil texture, tillage depth, and geometry of the tool. The mathematical expression for typical draught requirements of tillage implements provided by ASAE Standards (2003) is as follows:

$$D = F_i [A + B (S) + C (S)^2] WT \quad (13)$$

Where:

- D = Implement draught in N;
- F = Dimensionless soil texture adjustment parameter;
- i = 1 for fine, 2 for medium and 3 for coarse textured soils;
- A, B, and C = Machine-specific parameters;
- S = Field speed of tractor in km/h;
- W = Machine width in m or number of rows of tools; and
- T = Tillage depth in cm for major tools, 1 (dimensionless) for minor tillage tools and seeding implements.

Machine specific parameters and soil texture adjustment parameters for most tillage and seeding implements are presented in the ASAE (2003). The constant parameter, A is a function of soil strength, whereas coefficients of speed parameters B and C are related to soil bulk density. Soil is categorized as fine, medium and coarse textured soils. These categories are described as corresponding to clay, loamy and sandy soils. Ranges of typical speeds for most of the field machines are also given in the ASAE (2003).

2.3.4 Prediction of fuel consumption of farm machinery

Fuel consumption estimates used in farm and machinery budgets are based on the average annual fuel consumption, Q_{ave} [L/h] from agricultural machinery management and engineering practice (ASAE, 2003). Fuel consumption is also measured by the amount of fuel used during a specific time period. A measure of energy efficiency of a tractor is the specific volumetric fuel consumption (SVFC), which is given in the units of L/ kW.h. The specific volumetric fuel consumption is generally not affected by the engine size and can be used to compare energy efficiencies of tractors having different sizes under different operating conditions. The two fuel estimates Q_{ave} and SVFC for diesel fuel are obtained using the following equations (ASAE, 2003):

$$Q_{ave} = 0.223 P_{pto} \quad [l/h] \quad (14)$$

$$SVFC = 3.91 + 2.64 - 0.203\sqrt{738 X + 173} \quad [l/kW.h] \quad (15)$$

Where:

P_{pto} = Maximum PTO power of tractor

X = Ratio of equivalent PTO power required by an operation to P_{pto}

2.4 The Influence of Land Topography on Agricultural Mechanization

The agricultural mechanization in uplands lags behind that of lowlands because the steep gradients in uplands make the use of farm machinery difficult, and sometimes even dangerous (Miyazaki, 2001). Upland farmers are faced with difficulties in mechanization as in most cases they have limited opportunity for selection of suitable tractors and implements of new technologies due to unfavourable topography. Upland farmers need farm machinery with special design features including relative low position of centre of gravity and wider wheel track.

2.4.1 Characterization of sloping terrain topography

Terrain model contains two micro- and macro- topography variables that influence the field performance of tractors i.e. slope per cent and surface roughness (obstacles). Calculation of ground slope is fundamental to many traditional Geographical Information Systems (GIS) applications. Various methods exist for calculating slope. Manual slope generation, based upon contour line information, is a long established and generally accepted method (Ryder and Voyadgis, 1996).

Detailed mapping of the earth's surface configuration (slope) has always been time intensive. Traditional slope compilation methods are very labour intensive, requiring analysis of contour line information by a human interpreter (Ryder and Voyadgis, 1996). Compilation time can be dramatically reduced by using a computer to generate slope from digital elevation data. Key ingredients in this process are elevation data with adequate resolution and an algorithm that performs satisfactorily. Automated slope generation has been a topic of research for many years. Improved and new algorithms have been written. Rapid field collection of slope data is made possible through Global Positioning System (GPS) and laser range finding technology.

2.4.2 Analysis of tractor dynamics and stability on sloping land

Tractor instability on sloping land occurs when the weight transfer is sufficient to cause the tractor to overturn in any of the following three directions: rearwards, sideways, or forwards (Yisa and Terao, 1995). Of the three types of overturning situations, sideways overturning has been discovered to occur most often resulting in about 70% of the total overturning accidents (Yisa and Terao, 1995). Forward overturning accidents are very rare and their study has received little attention. Although rearwards overturning covers

just about 30% of reported tractor overturning cases, they are more likely to result in fatalities than sideways overturning accidents.

Macmillan (2002) pointed out that impending rearward instability (where the front wheels leave the ground and the tractor is on the point of becoming unstable) is considered an undesirable situation because it represents loss of steering control and may lead to actual instability. Such a situation is partly avoided by inherent features of the design of the tractor-implement system and partly by its operation in a way that avoids reaching that condition (Harshman *et al.*, 2004).

A lot of resources have been expended in the last six decades on the research into tractor stability and dynamics in different countries (Yisa and Terao, 1995). However, tractor accidents are still many. This situation necessitates the continuation of research into dynamics of tractor and implement systems embracing both the demand for human safety factors and better performance challenges as illustrated in Fig. 6. It has been argued by Yisa and Terao (1995) that more research emphasis should be directed towards tractor-implement systems operating on slopes since critical situation are more likely to occur in the area.

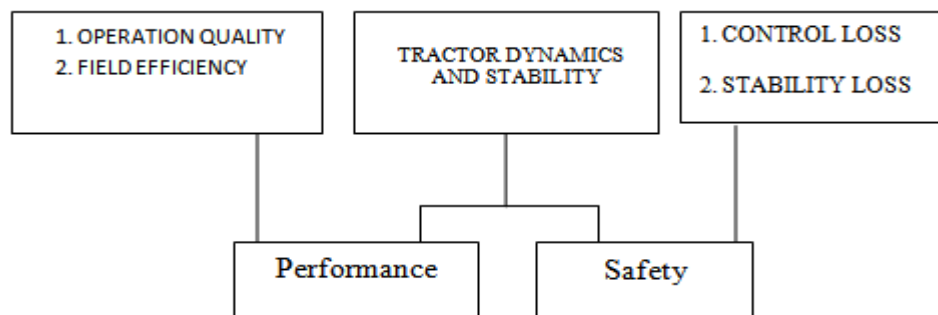

Figure 6: Challenges related to tractor dynamics and stability (Yisa and Terao, 1995).

There are two categories of tractor overturning accidents on slopes, which always have serious consequences for the farmer namely: stability loss and control loss. The stability loss is when the tractor overturns directly. The control loss is when the tractor slides bodily downhill before overturning. These accidents arise in a wide variety of circumstances: tractor alone, tractors with mounted or trailed equipment on both steep and gentle slopes. Overturning accidents arise from reaching the limit of static stability, reaching stability limit under dynamic conditions or sliding out of control (Harshman *et al.*, 2004).

Hazards on slopes are present when a tractor is climbing uphill, travelling downhill, or travelling across the slope. Sliding downhill will occur if the ground is too slippery for the tractor to remain under control; this is common on grass fields and is also likely on loose surfaces. Skidding or overturning on the other hand will occur when cornering at too high speed. Sideways overturning will occur on too steep slopes and on rough ground. Accelerating uphill will cause rearwards overturning or slipping, while with certain designs the machine will tip forwards when braking during descent. An understanding of the actual process of overturning in the vertical rearwards plane requires a different, more complex dynamic analysis. The analysis includes, among other matters, the inertia of the tractor chassis and of the implement.

According to Yisa and Terao (1995) a conventional tractor may tip sideways about two axes as indicated in Fig. 7. The overturning motion first takes place about an axis connecting the hinge point of the front axle to the contact point of the rear tyre remaining on the ground during the initial overturning motion. Eventually, the tipping part of the tractor strikes a stop on the front axle assembly with further tipping of the entire tractor

taking place about the axis connecting the contact points of the front and rear tyres on the side of the tractor about which the initial motion took place (Yisa and Terao,1995).

A major interest in tractor dynamics is to determine its stability for a given condition, particularly the stability against overturning on sloping agricultural fields. The stability of a tractor assumes that a tractor will follow a set path and change paths under the operator's control.

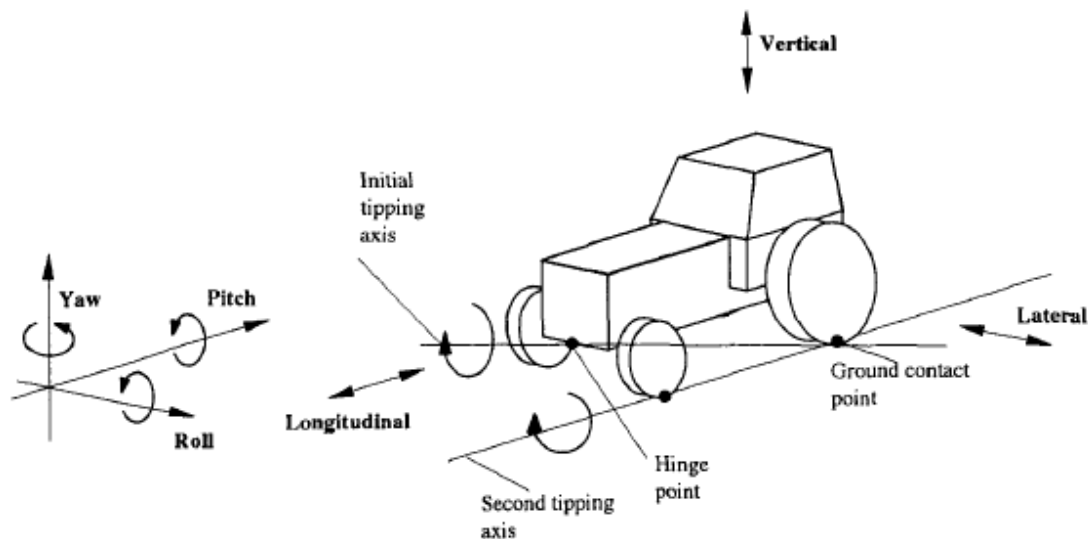

Figure 7: Six degrees of freedom of a tractor and tipping axes in a sideways overturn (Yisa and Terao, 1995).

2.4.3 Determination of stability of tractor-implement system on slopes

Determination of stability of a tractor on a slope has been done in different ways. The test of static stability is based on measuring the weight transfer on a moderate slope and then predicting the slope angle where an uphill wheel will carry no load. The dynamic effects of cornering, acceleration and deceleration can be calculated directly in terms of adjustments to the static stability limit, provided these effects remain constant (Simion and Nastase 2009).

The stability of tractor on slope may be expressed in terms of Stability Index (SI) (Ahmadi, 2011). One proposal being made is that the index is a slope value, defined as the minimum slope on which a dynamic test causes a tractor to tip halfway towards overturning. A tractor with a high stability index will be more stable than the one with a low stability index. The stability index is a valuable indicator of tractors which are safer to use on slopes and it can be used to propose maximum operating slope for individual tractors. However, the index will not in itself define a safe slope because it will always be possible to cause an overturn, on level ground, by violent manoeuvres and harsh driving. A stability index provides a standard measure with which the stability of different tractors may be compared. Thus, the stability indices of different makes of tractors form a basis or criteria for selection.

Determining the stability of agricultural tractors has been a concern of tractor designers and researchers for many years. Considerable research has been conducted on tractor overturning stability and dynamics on sloping ground (Yisa *et al.*, 1997; Miyazaki, 2001; Simion and Nastase, 2009). Studies were conducted to determine the factors influencing the directional stability of a tractor on a slope. Much of the work was connected to establishing safe operating slopes.

A comprehensive study of tractor stability and control on slopes with straight traverses of various slopes was conducted by Gilfillan (1978). His work established stability and control limits of tractor operation on slopes without a steering manoeuvre. Yisa *et al.*, (1997) developed mathematical model of tractor-mounted implement combination shown in Fig. 8 to predict stability on slopes. The overall objective of the study was to be able to analyse tractor and implement models at design stage in terms of their general stability and slope performance. The procedure employed by Yisa *et al.*, (1997) was based on

implement centre of gravity, T_1, T_2, T_3, T_4 = traction forces, X, Y = ground fixed coordinate system, x, y = vehicle fixed coordinate system, ω_z = yaw velocity of the tractor centre of gravity [rad/s], δ = steer angle [rad], ϕ = slope angle [rad], ψ = heading angle [rad].

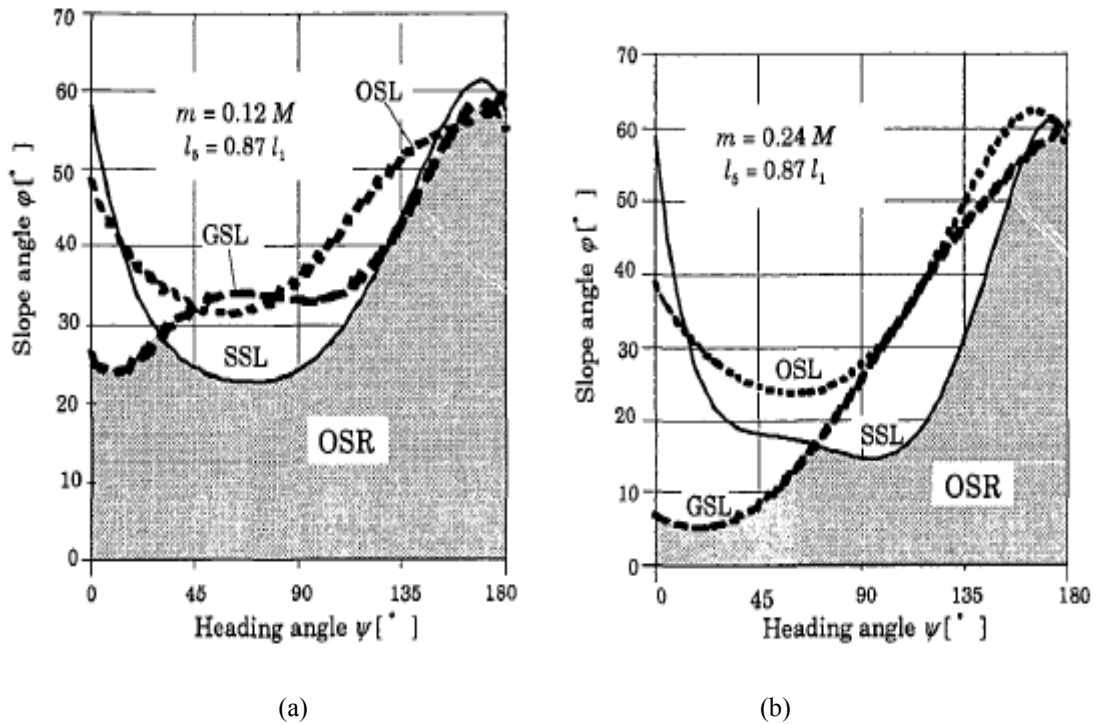

Figure 9: Stability regions for a tractor-mounted implement combination (Yisa *et al.*, 1997).

(a) $m = 0.12M$, (b) $m = 0.24M$; M = Tractor weight, m = implement weight, SSL = Slip Stability Limit, OSL = Overturning Stability Limits, GSL = General Stability Limits, OSR = Overall Stability Region, l_1 = wheelbase [m], l_5 = distance from rear axle to implement centre of gravity [m]

Miyazaki (2001) conducted a study to develop a mechanized farming system for slope land citrus orchards which in the past had been carried out manually, since there had been no suitable machinery. They involved the construction of farm paths, and the use of small and light machines such as lawn-garden tractors, power tillers etc. The new mechanized

system was reported to have reduced the total work hours by more than 30%, while farmers' income increased resulted from the improved quality of the citrus fruit.

Macmillan (2002) demonstrated the analysis of forces acting on a tractor-implement system in the rearwards, vertical plane as shown in Fig. 10. The analysis was limited to the calculation of wheel weight during steady state operation in normal work and to the prediction of the conditions for impending instability. For the calculation of wheel weight during steady state operation in normal work, the equation of equilibrium was established by taking moments about C.

$$V_f \cdot x + W \sin \alpha \cdot y_g + P \sin \theta \cdot x' + M = W \cos \alpha \cdot x_r + P \cos \theta \cdot y \quad (16)$$

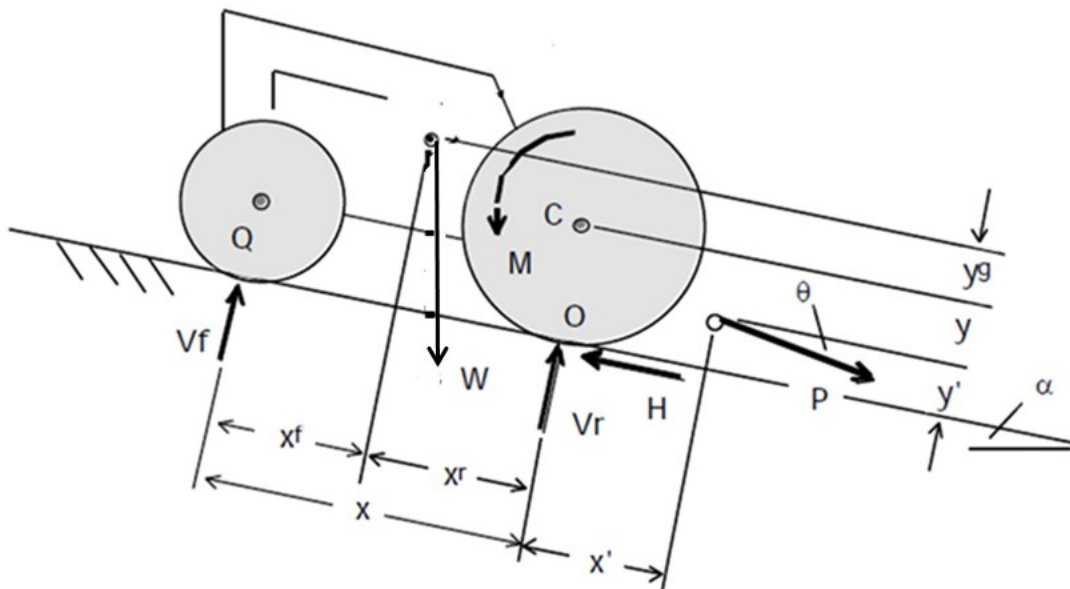

Figure 10: Operating parameters for tractor on slope with impending instability (Macmillan, 2002).

α = angle of slope of ground surface, θ = angle of draught, H = traction force, P = drawbar pull, W = weight of tractor, M = moment on wheel / chassis, x = wheel base, $x' =$

distance from rear axle to hitch point, x_f = distance from front axle to centre of gravity of tractor, x_r = distance from rear axle to centre of gravity of tractor, y = distance from rear axle to hitch point, perpendicular to the ground surface, y' = distance from ground contact point to hitch point, perpendicular to the ground surface, y_g = distance from rear axle to centre of gravity for tractor perpendicular to ground surface, V_f = dynamic weight on front wheels, V_r = dynamic weight on rear wheels.

The weight on the front wheels (V_f) perpendicular to the slope was given by:

$$V_f = W_f - W \sin \alpha \frac{r+y_g}{x} - P \cos \theta \frac{y'}{x} - P \sin \theta \frac{x'}{x} \quad (17)$$

Where: r is the radius of the rear wheels

The weight on the rear wheels (V_r) perpendicular to the slope was given by:

$$V_r = W_r + W \sin \alpha \frac{r+y_g}{x} + P \cos \theta \frac{y'}{x} + P \sin \theta \frac{x+x'}{x} \quad (18)$$

For impending instability $V_f = 0$. From this condition various tractor design parameters namely x , x_r , x_f , y_g , y' , and x' were determined under specific slope angle. Abu-Hamdeh and Al-Jalil (2004) simulated the dynamics and stability of a tractor-trailer system moving up and down sloping ground under different operating conditions (Fig.11).

They developed a computer program to analyse the system to predict the effect of both the trailer loading weight and the slope angle on the tractor stability, traction ability, and drawbar loading. The program was used to analyse a tractor-trailer system moving at uniform motion up and down hill. A 2WD tractor in combination with a single axle trailer was considered in this study. The analysis was based on the following assumptions: (a) Line of action of the drawbar pull P is located midway between the

traction wheels and parallel to the traction surface, (b) Line of action of the normal soil reaction passes through the centre of wheels; and (c) Lines of action of the traction forces and rolling resistances are tangent to the wheels.

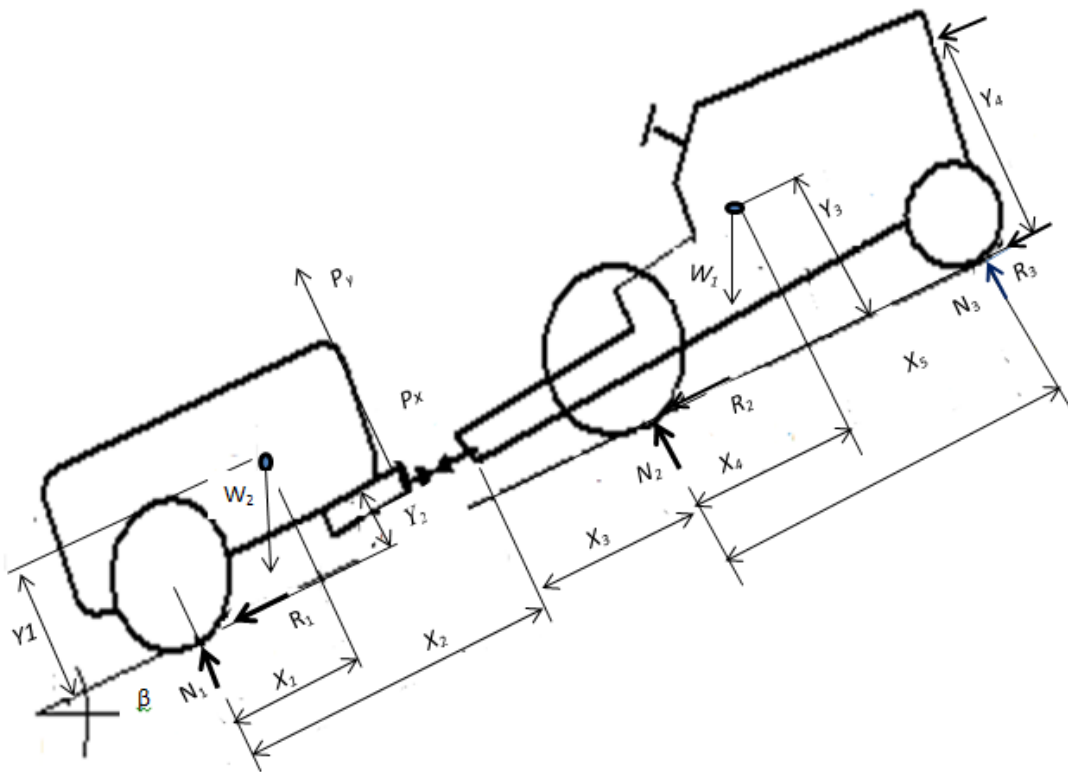

Figure 11: Schematic of representation of forces acting on tractor-trailer system (Abu-Hamdeh and Al-Jalil, 2004).

y_1 = height of the centre of gravity of trailer above the ground, y_2 = height of the tractor hitch point above the ground, y_3 = height of the centre of gravity of tractor above the ground, y_4 = height of the air resistance, x_1 = distance of centre of gravity of trailer forward of the axle of the trailer, x_2 = distance of axle of trailer rearward of the hitch point, x_3 = distance of hitch point rearward of the rear axle of the tractor, x_4 = distance of centre of gravity of tractor forward of the rear axle of the tractor, x_5 = wheel base of the tractor, W_1 = weight of tractor, W_2 = weight of trailer, N_1 = soil reaction against the trailer wheels, N_2 = soil reaction against the rear wheels of the tractor, N_3 = soil reaction against the front

wheels of the tractor, R_1 =rolling resistance of the trailer wheels, R_2 = rolling resistance of the rear wheels of the tractor, R_3 = rolling resistance of the front wheels of the tractor, P_y = normal component of the drawbar pull to the traction surface, P_x = parallel component of the drawbar pull, R_A = air resistance, β = angle of the uphill grade relative to horizontal.

The results reported by the researchers showed that the tractor became unstable when towing a 3 750 kg trailer uphill at 28° slope angle. They also reported that insufficient traction occurred at slope angles ranging from 15° to 18° corresponding to trailer weight of 3 750 to 7kg respectively. According to them the parallel component of drawbar pull reached a maximum value of 17 318 N when the trailer was pushing the tractor downhill at 30° slope angle. The normal component (normal to the traction surface) showed similar maximum values for both uphill and downhill motions of the system. The authors concluded that the use of computer analysis in the study provided a significant improvement in predicting the effect of different parameters on stability and control of tractor-trailer combination on sloping ground.

Simion and Nastase (2009) conducted a study to analyse the rearwards and sideways stability of tractor–implement systems in the critical situations on sloping land surface. The analysis involved tractor-front end loader system and tractor-forklift system. Mathematical models for analysis of the rearwards and sideways stability of tractor-loader systems on slopes were developed. The mathematical models describe the dynamic behaviour of the system under working and transportation situations. The mathematical models of tractor–loader systems allowed the analysis of the rollover stability of the systems, for various working and travelling conditions on slopes.

In the diagram of Fig. 12, Simion and Nastase (2009) consider that the most critical stability situation is when the tractor and the load Q are braked simultaneously during descending and lowering respectively. From the dynamic equilibrium analysis the normal forces Z_1 and Z_2 on the front and rear tyres respectively are given by the following expressions:

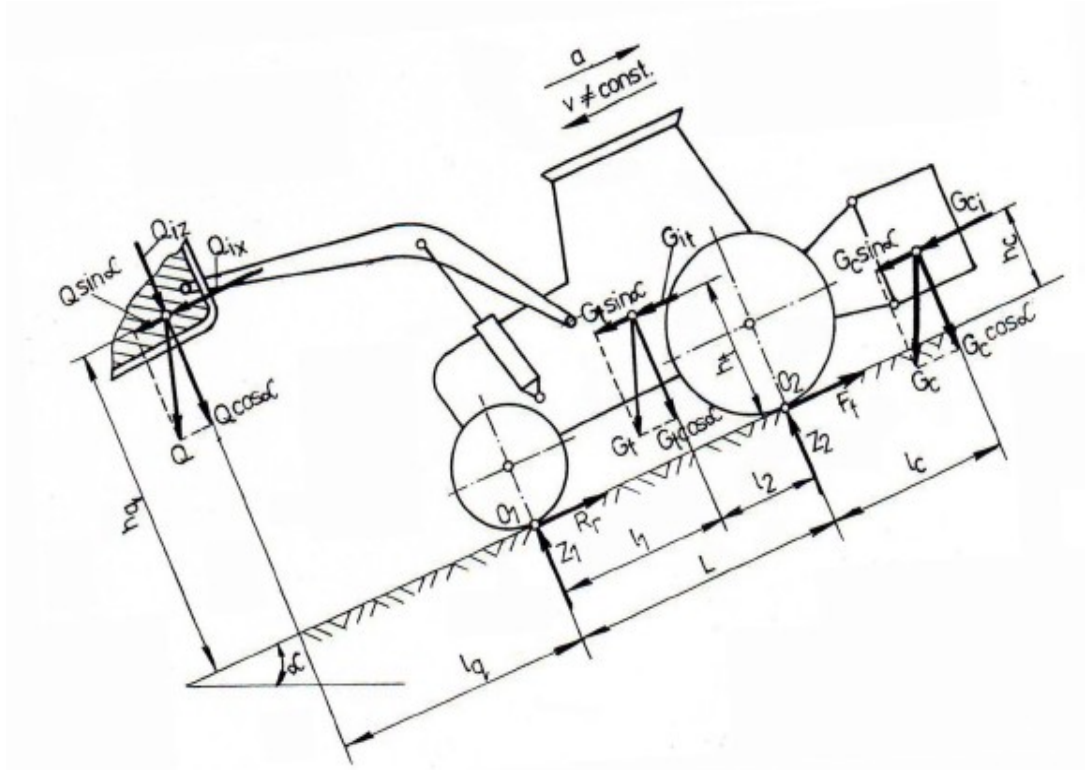

Figure 12: External forces acting upon a tractor-loader system descending downhill a slope (Simion and Nastase, 2009).

G_c = weight of counterweight G_t = weight of tractor, Q = weight of loaded bucket, Z_1 = Load on the front axle, Z_2 = Load on rear axle, R_r = total rolling resistance on the tractor wheels, h_t = height of the centre of gravity of tractor above the ground, l_1 = distance of centre of gravity of tractor rearward of the front axle of the tractor, l_2 = distance of centre of gravity of tractor forward of the rear axle of the tractor, l_c = distance from the rear axle to the centre of gravity of counter weight, L = wheel base, l_q = distance from the front axle to the centre of gravity of loaded bucket, F_t = traction

force developed on rear wheels, $0_1, 0_2$ = wheel/soil contact points of front and rear wheel respectively, h_c = height of the centre of gravity of counterweight above the ground, h_q = height of the centre of gravity of loaded bucket above the ground, α = slope angle.

$$Z_1 = \frac{[G_t l_2 + G_c l_c + Q(L+l_q)] \cos \alpha}{L} + \frac{(G_t h_t + G_c h_c + Q h_q) \sin \alpha}{L} + \frac{(G_t h_t + G_c h_c + Q h_q) d + Q l_q \cdot a_q}{L \cdot g} \quad (19)$$

$$Z_2 = \frac{[G_t l_1 - G_c(L+l_c) - Q l_q] \cos \alpha}{L} - \frac{(G_t h_t + G_c h_c + Q h_q) \sin \alpha}{L} - \frac{(G_t h_t + G_c h_c + Q h_q) d + Q l_q \cdot a_q}{L \cdot g} \quad (20)$$

Where:

d = braking deceleration of descending tractor

a_q = deceleration during lowering of loaded bucket

The value of the maximum deceleration d_{\max} for which the rearwards stability is ensured is determined from equation (21) by condition $Z_2 = 0$:

$$d_{\max} = g \cdot \frac{[G_t l_1 + G_c(L+l_c) - Q l_q] \cos \alpha - (G_t h_t + G_c h_c + Q h_q) \sin \alpha}{G_t h_t + G_c h_c + Q h_q} \quad (21)$$

In case of tractor-mounted forklift system Fig. 13 the most critical stability situation is when brakes are applied to the system during descending along a slope. The situation becomes more critical when the charge Q is simultaneously decelerated during the lowering process.

From the dynamic equilibrium analysis, the normal load Z_1 on the front axle of the braked tractor-forklift system with deceleration d during descending a slope was expressed by Simion and Nastase (2009) as follows:

$$Z_1 = \frac{[G_t l_2 - G_c(L+l_c) - Ql_q] \cos \alpha - (G_t h_t + G_c h_c + Q h_q) \sin \alpha}{L} - \frac{(G_t h_t + G_c h_c + Q h_q) d + Q l_q \cdot a_q}{L \cdot g} \quad (22)$$

The system loses its rearwards stability (overturns round the rear axle) when the load on the front axle Z_1 becomes zero. Condition $Z_1 = 0$ in equation 19 allows establishing of the maximum (critical) value of the slope angle α_{max} , or of the braking decelerations of the system d_t or of the braking decelerations d_q of the load Q at which the system loses its dynamic stability.

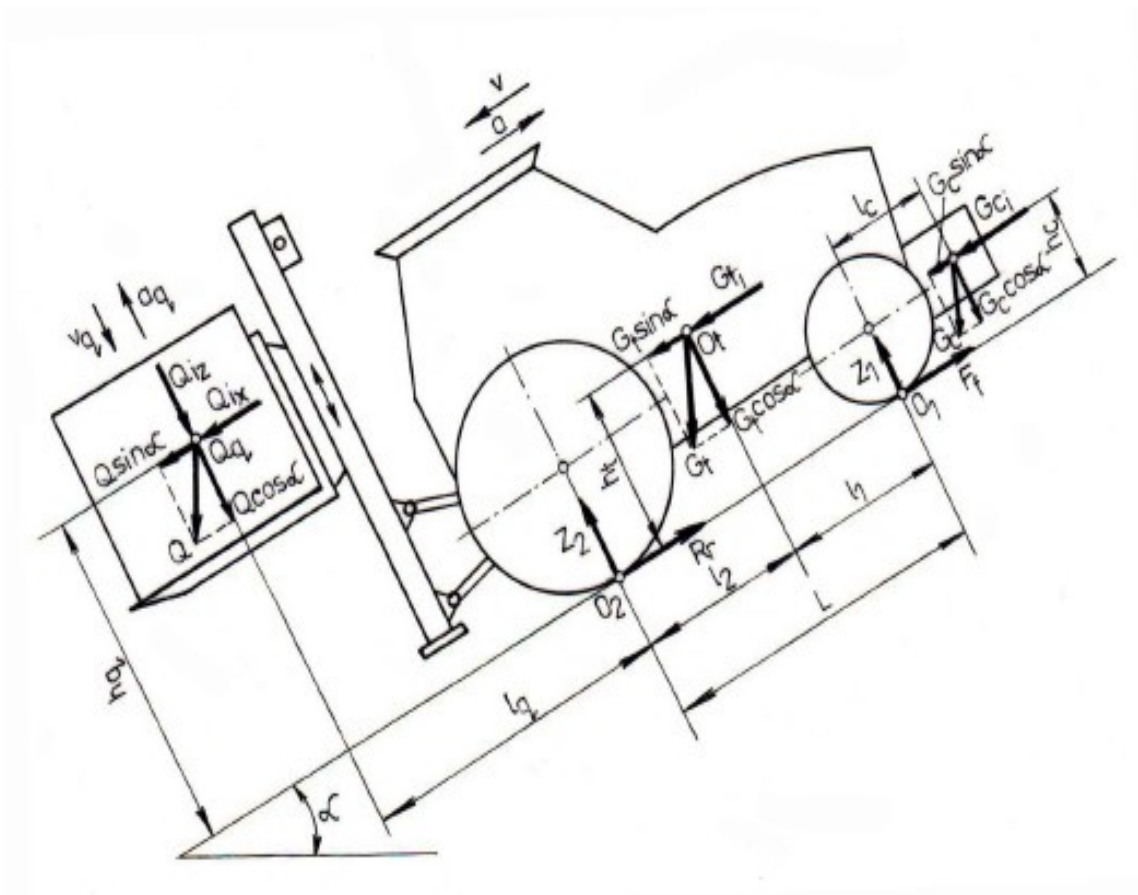

Figure 13: Forces acting on the tractor- forklift system operating on sloping road (Simion and Nastase, 2009).

G_c = weight of counterweight G_t = weight of tractor, Q = weight of loaded bucket, Z_1 = Load on the front axle, Z_2 = Load on rear axle, R_r = total rolling resistance on the tractor

wheels, h_t = height of the centre of gravity of tractor above the ground, l_1 = distance of centre of gravity of tractor rearward of the front axle of the tractor, l_2 = distance of centre of gravity of tractor forward of the rear axle of the tractor, l_c = distance from the rear axle to the centre of gravity of counter weight, L = wheel base, l_q = distance from the front axle to the centre of gravity of loaded bucket, F_t = traction force developed on rear wheels, O_1, O_2 = wheel/soil contact points of front and rear wheel respectively, h_c = height of the centre of gravity of counterweight above the ground, h_q = height of the centre of gravity of loaded bucket above the ground, α = slope angle.

To ensure manoeuvrability, at least 20 % of the tractor weight G_t needs to remain on the front axle (which is the steering axle), that is $Z_{1\min} = 0.2.G_t$. By imposing this condition, the maximum values of the slope angle α (with various decelerations) can be computed by the equation (23). The researchers also analysed the dynamics of tractor - front loader system with charged bucket moving across a slope (Fig. 14). From the equilibrium equations of the system the normal reaction (perpendicular on the road surface) in the uphill Z_s was given by the expression:

$$Z_s = \frac{0.5E(G_t+Q) \cos \beta - (G_t h_t + Q h_q)}{E} \sin \beta \quad (23)$$

The sideways overturning stability of the tractor – loader system was given by the condition $Z_s > 0$. After transformations the stability condition to sideways overturning was expressed as follows:

$$\frac{0.5 E(G_t+Q)}{(G_t h_t + Q h_q)} \geq \tan \beta \quad (24)$$

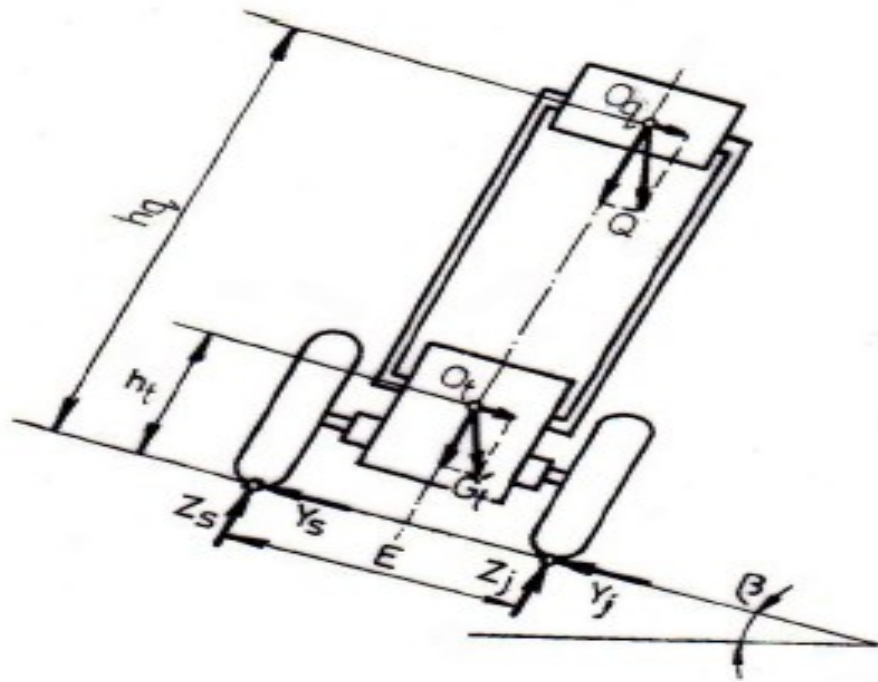

Figure 14: Forces acting on the tractor - loader system when moving across the slope (Simion and Nastase, 2009).

G_t = weight of tractor, Q = weight of loaded bucket, h_t = height of the centre of gravity of tractor above the ground, h_q = height of the centre of gravity of loaded bucket above the ground, Z_s , Z_j = normal reaction of soil on the upper side and down side wheels respectively, Y_s and Y_j = sideways forces on upper side and downside wheels respectively, O_t , O_q = centres of gravity of tractor and loaded bucket respectively, β = Slope angle E = wheel track.

2.5 Farm Machinery Cost Analysis

Agricultural engineers and economists use a variety of engineering and economic principles in calculating a machine's use and costs (Kasterns, 1997). An effective farm manager must also know these principles and apply them when deciding to buy, lease, rent or share machinery. Once a particular type of tillage, planting, weed control, or harvesting machine has been selected, the question of how to minimize machinery costs

must be answered (William, 2002). Machinery that is too large for a particular farming situation will cause machinery costs to be unnecessarily high over the long run. On the other hand, machinery that is too small may result in lower crop yields or reduced quality (Schuler, 2006).

The most accurate method of determining machine costs is complete records of the actual costs incurred (Bakhit *et al.*, 2006). When estimating costs, methods that require more data specific to your situation, the more accurate will be the estimate. Often the estimate is done by obtaining list prices from machinery dealer surveys and using ASABE machinery data and formulas (ASABE, 2006). Schuler (2006) developed a series of tables and two worksheets, one for tractors and one for other implements to help estimate machine costs using the ASABE data and formulas.

2.5.1 Types of costs

Costs of agricultural machines fall into two categories namely fixed cost and variable cost. Fixed (ownership) costs are defined as the costs which do not depend on the amount of machine use (William, 2002). Fixed costs are incurred regardless of the number of acres or hours of use annually. They include depreciation, taxes, garage, insurance, interest and repairing cost (sometimes). A simple estimate of total annual fixed (ownership) costs is given by multiplying the purchase price of the machine by the ownership cost percentage (Appendices 41-43),(Schuler, 2006):

$$AFC = P * RAF / 100 \text{ (or } AFC = P * raf) \quad (25)$$

Where:

$$AFC = \text{Annual fixed costs [TZS]}$$

- P = initial (purchase) price [TZS]
 raf = Annual fixed cost rate [decimal]
 RAF = Annual fixed cost rate [%]

Since most tractors are used for several different operations, the fixed costs per hour (T_{fch}) must be known in order to distribute these costs among all operations. This is done by dividing the tractor's annual fixed costs by the estimated annual hours (Mpanduji *et al.*, 2004).

Variable (operating) costs are defined as the costs which depend directly on the amount of machine use i.e. they vary in proportion to the amount of machine use. Variables costs include labour, fuel, lubrication, and repair and maintenance costs (Schuler, 2006). The variable costs (C_V) are calculated using the expression (26).

Where:

$$C_V = F_V + L_V + R_V + W_V + M_V \quad (26)$$

- F_V = Fuel cost [TZS]
 L_V = Lubricant cost [TZS]
 R_V = Repair cost [TZS]
 W_V = Labour cost (wage) [TZS]
 M_V = Material cost of farm work [TZS]

The variable costs per hour must be known and this is done by dividing the tractor's annual variable costs by the estimated hours used by tractor for all purposes during the year. The Total variable cost per hour (C_{Vh}) of farm work is calculated using the expression (27).

$$C_{Vh} = F_{Vh} + L_{Vh} + R_{Vh} + W_{Vh} + C_{VF} + M_{Vh} \quad (27)$$

Where:

- F_{Vh} = Fuel cost per hour
- L_{Vh} = Lubricant cost per hour
- R_{Vh} = Repair cost per hour
- W_{Vh} = Labour cost (wage) per hour
- C_{VF} = Variable cost per hour originated from fixed cost
- M_{vh} = Material cost per hour

The annual cost for ploughing operation is calculated by using the following expression (Bakhit *et al.*, 2006).

$$AC = \frac{Fc(\%)P}{100} + \frac{c.A}{S.W.e} (RVh + WVh + LVh + FVh + Mvh + Tfch) \quad (28)$$

Where:

- AC = Annual cost of operation of implement,
- Fc% = fixed cost percentage of plough price
- P = Purchase price of the plough, [TZS]
- C = Conversion factor = 10 (Bakhit *et al.*, 2006)
- A = Area to be cultivation, ha
- S = Working speed, km/h
- W = Effective width of plough, m
- e = Field efficiency
- T_{fch} = Tractor fixed cost per hour, [TZS]

2.6 Selection of Farm Tractors and Equipment

Farm tractors and implements selection is an important part of machinery management for small holders or in large-scale mechanized schemes. Proper planning and selection of farm equipment can help to assure profitable farm operations that meet the current and future goals of the farm. Economic sustainability of farm operations depends partially on the ability of managers in proper selection and management of farm machinery (Grisso *et al.*, 2006).

At an enterprise level the first step in planning a crop production system for a given farm is to select the most appropriate farm equipment among many available options. Although some systems are best for certain situations, none are generally preferred for all applications (Edwards, 2002). Many factors must be considered when developing an appropriate system for a given farm. Factors like the investment in equipment and structures, losses, the labour and fuel requirements are important considerations.

The diversity in the makes, types, and sizes of tractors and implements offered in the market are among the factors to be considered. Selection of farm machinery is also influenced by soil types, cropping patterns, topography, and scale of farming. Many of these variables are unpredictable. The goal of the good machinery manager, therefore, should be to have a system that is flexible enough to adapt to a range of weather and crop conditions, while minimizing long-run costs and production risks (Edwards, 2002). The availability of data relating to draught requirement of tillage implements is an important factor in selecting suitable tillage implements for a particular farm situation.

Computer models and simulation programs have been used to predict draught and power requirement of tillage implements on different soil types and conditions to determine

correctly the proper size of tractor required (Al-Hamed and Al-Janobi, 2001). Computer models and simulation programs for predicting the performance of tractors and implements have helped researchers, farm managers and consultants to evaluate various farm machinery systems to determine the relative merits of each system (Al-Hamed and Al-Janobi, 2001). Proper selection of tractor and implement for a particular farm situation can be determined from the performance parameters obtained by these models and simulation programs (Summer and Williams, 2007).

2.6.1 Previous models for selection of tractors and implements

Many models for selection of tractor-implement systems have been developed for given cropping systems (Osborn and Barrick, 1970; Rotz *et al.*, 1983; Al-Hamed and Al-Janobi, 2000; Abbaspour-Gilandeh *et al.*, 2007; Vatsa and Saraswat, 2008). Osborn and Barrick (1970) developed a computer model to select the power and equipment combinations that would minimize annual power and machine costs. A set of tractor and implement was chosen to satisfy the available drawbar pull, draught, upper and lower speed requirements, farm size and the time allotted for the operation. Output of the model included the number and sizes of all tractors and each type of implement selected, hours of use, variable cost per hour, and per acre associated with each implement (Rotz *et al.*, 1983).

Chaplin *et al.* (1988) developed a computer program that predicted the performance of a tractor- implement system. The model used the then widely accepted Wismer and Luth empirical equations. Input information included tractor type, implement type, computational units, tractor weight, no-load speed, engine power, soil cone index, tractor wheelbase, tyre size, and tractor weight distribution. Output of the program included:

traction efficiency, wheel slip, ground speed, and draught along with a plot of traction efficiency against wheel slip.

Machinery selection model was developed by Siemens (1997) to select an optimum set of machinery for a given cropping system. The model used the principles of machinery sizing and economic evaluation to develop feasible machinery sets and to select the economically optimum set for a given farm size and crop rotation. According to Siemens (1997) the timeliness cost for delay in planting or harvesting can be included with the production costs providing the optimum or overall least cost machinery system for completing the work.

Camarena *et al.* (2004), using mixed integer linear programming linked to several databases contained in spread sheets to select agricultural machinery for a multi-farm system. The program selects the machinery set for each farm, which corresponds to the lowest annual mechanisation cost of the multi-farm system. The input information consists of variable and fixed costs from the multi-farm, the schedule of operations and the different combinations of equipment and the area of each farm.

The program works under the environment of the worksheet and the user does not require knowledge of linear programming to understand the input and output of the model program. The program is capable of calculating the number of working days required for each tractor–implement at each farm in the different periods. It also allows studying the effect of changing values on fixed and variable costs.

Grisso *et al.* (2006) carried out a study to demonstrate the use of spread sheet for selection and matching tractors and implements. The spread sheet was based on the Brixius models and ASAE Standards D497.5 to predict tractor performance and

implement draught respectively. Two sets of cases selected to demonstrate the use of spread sheet included matching either the tractors with the implements, or the implements with the tractors. Cases considered in their study, included three tractors of different power levels and configurations, three different implements and three different soil types. The results of their study showed that the spread sheet can be used effectively to match implements with tractors or vice versa. They also reported that the optimization of weight distribution for maximum power delivery efficiency, and computation of field capacity and fuel consumption were possible with the use of spread sheet.

Abbaspour-Gilandeh *et al.* (2007) developed a user friendly and flexible computer program for predicting tractor's field performance on agricultural soils. The program was written in Visual Basic Language. The model used a general form of Brixius (1987) traction equations. The programme predicted the performance parameters as well as fuel consumption of a given tractor by accessing databases concerning tractor specifications, tyre information, and soil condition and traction equation coefficients. The tractor specifications database contained information such as tractor make and model, power, tractor type, tyre type and size, number of tyres, static weight on front and rear axles, wheelbase, draught height, draught angle, distance behind rear axle, no-load speed, and cone index. Simulation results included: traction efficiency, dynamic weight on front and rear axles, Gross traction ratio (GTR), Motion resistance ratio (MMR), Net traction ratio (NTR), wheel slip, drawbar pull, drawbar power and actual speed.

Vatsa and Saraswat (2008) developed a computer program in turbo C++ language to select power tiller and the size of implement. The program employed farm power and machinery cost equations proposed by Hunt (1983). The essential inputs to the program were: area under different crops, cropping pattern and soil type for a particular farm

situation, price of power tiller, implement, optimum number of operations for different crops, yield of crop etc.

Raheman (2008) conducted a study to develop a computer program in Visual Basic 6.0 to select the suitable tyre size for any power range of tractor, considering Brixius, ASAE draught and developed weight-to-power models for tractors. The program requires information on tractor, implement, tyre, soil and operating conditions. The output of the program provides the suitable tyre size that gives best performance in terms of load carrying capacity, pulling ability, coefficient of traction and traction efficiency with minimum purchasing cost.

2.6.2 Summary

The literature review indicates that extensive information has been published on the subject of selection of tractors and implements for particular farm situation based on the performance parameters obtained by computer models and simulation programs. The farm machinery selection models developed so far have used different selection criteria including (a) physical variables such as drawbar pull and draught force and (b) economic variables such annual total costs (fixed costs and operating costs). The most common objective of farm machinery selection had been to select machinery in the size range in which total machinery costs are lowest. The literature survey has also shown that there are other crucial tractor performance factors that have not been considered during the selection of optimum tractor-implement systems. Such factors include tractor stability and safety on sloping terrain. It is therefore hypothesized that when the stability of tractor-plough combination on sloping farmland is used as one of the criteria in the development of a tool for selection of optimum farm machinery, the developed model will be more versatile i.e. can be applied in both upland and lowland (plain) farming systems.

CHAPTER THREE

3.0 MATERIALS AND METHODS

This chapter presents materials and procedures used in collection and analysis of data. The first section provides the description of the study area and section two explains the research design and sampling procedures. Section three describes data collection methods while section four outlines data analysis procedures.

3.1 Description of the Study Area

The study was conducted in Mvomero District located between 5.8° - 7.4° S and 38.2° - 38.8° E, in Morogoro Region. Mvomero, one of the five districts in the Morogoro region, is a rural district composed of 101 villages with a total population of about 288,559 in year 2006 (MDC,2009)(Fig.15). The District varies greatly in its topography and climate. Mountains and highlands are located in the northwest, lowlands rainforest in the north and central area, and drier wood lands in the south.

Rainfall in the district is bimodal with long wet season from March to May and short wet season from October to December. Average annual temperatures in Mvomero range from $20 - 30^{\circ}$ C. The northern area has humid to sub humid climate and annual rainfall ranges from 1 500 to 2 000 mm while the southern part of the district is much drier, with annual rainfall between 600 and 1 200 mm. Mvomero District is bordered to North by Tanga Region to the North-East by Coast region to the East and South by Morogoro rural District and to West by Kilosa District.

The majority of the district's economic activity is derived from agricultural crop production, but the southern part is composed primarily of pastoralist livestock-keeping.

According to MDC (2009) about 80% of the population of the district depends on crops and livestock as the major basis of their livelihoods. Main crops in the division include rice, maize, cassava, fruits, and vegetables as well as large scale sugarcane and sisal plantations.

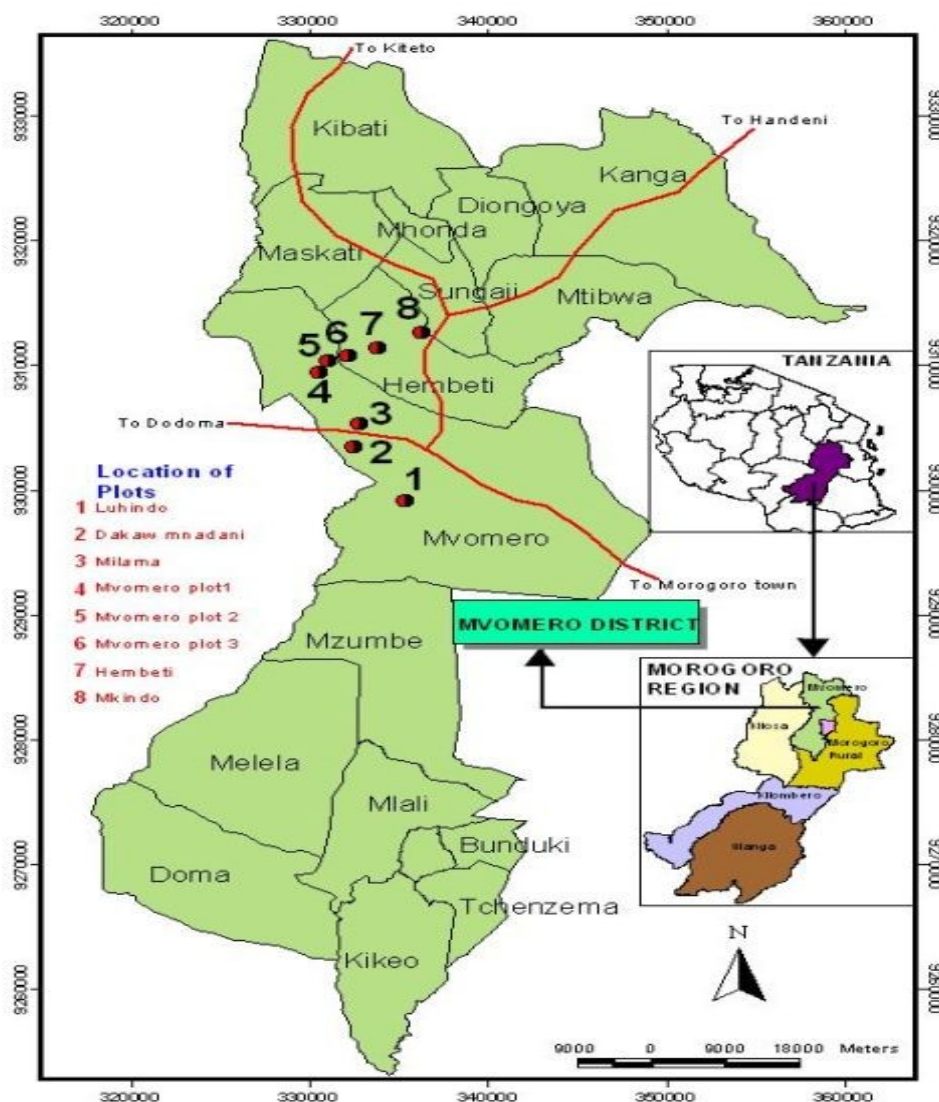

Figure 15: Map of the study area with located test plots.

3.2 Research Design

The research study was typically of case study design where the researcher conducted it through surveys in Mvomero Division. This design was adopted because it is

comparatively less expensive, flexible and easily manageable in the process of data collection and it provides more insight towards obtaining in depth and breadth information about several variables from within geographical and social units.

The study was cross-sectional, where the survey information was collected at one point in time. Research activities were carried out by involving both quantitative and qualitative research study. Quantitative research is based on the measurement of quantity or amount. It is applicable to phenomena that can be expressed in terms quantity. Qualitative research, on the other hand, is concerned with qualitative phenomena, i.e. phenomena relating or involving quality or kind (Kothari, 2004).

3.2.1 Study population

All items in any field of inquiry constitute a population. Population refers to the entire group of people, events or things of interest that the researcher wishes to investigate (Franklin and Walker, 2010). In the present study survey and field tests were carried out on eight selected sites (Fig.15) and the population was 242 people. This population of people was made up of 205 farmers (84 were tractor- owners) and 19 tractor operators in Mvomero division. The population also included 4 Extension workers, 3 farm managers of mechanized farm schemes, 5 Tractor repair and maintenance service providers, and 6 dealers of tractors and implements operating in Mvomero District and Morogoro Municipality.

3.2.2 Sample size determination and sampling techniques

The study population of tractor-owners and non-tractor-owners farmers was not homogeneous and therefore, stratified sampling was applied in order to obtain the representative sample. In the light of this fact, simple random sampling was used to

obtain a sample size of 70 tractor owners from Mvomero division to represent the total population at confidence level of 95% and level of precision of 5%, using the following formula (Kothari, 2004):

$$n = \frac{N}{1+N(e^2)} \quad (1)$$

Where

n = the sample size

N = the population size = 84

e = the level of precision (sampling error) = 5% or 0.05

$$n_1 = \frac{84}{1+84(0.05^2)} = 70$$

A simple random sampling was also used to obtain a sample size of $n_2 = 70$ from a list of 84 non-tractor owners who benefited from hiring services provided by tractor owners.

In addition to the sample of 140 farmers, 37 respondents were also interviewed during the study. They included 19 tractor operators, 3 mechanization extension officers, 3 farm managers of mechanized farm schemes, 5 Tractor repair and maintenance service providers, and 6 farm equipment dealers operating in Mvomero district and Morogoro Municipality. The enumerators visited each selected farmer's household using an extension worker and a local village sub – leader as a guide.

3.3 Data Collection

3.3.1 Collection of agricultural mechanization data

3.3.1.1 Collection of primary data

Structured schedules and questionnaires of closed ended and open ended questions (Appendices 18 - 22) were used to collect socio-economic data from 140 farmers (tractor owners and non-tractor-owners). The research instruments were developed based on a prior experience and survey conducted by the Ministry of Agriculture, Food Security and Co-operatives (MAFC), (2008) in the Eastern and Central Zones. Before collecting data, the instruments were pre-tested to a group of randomly selected farmers and these pre-tested surveys were not included in the final data set.

(a) Quantitative primary data

The following quantitative data were collected and used in this study: area of owned farmland, size of cultivated farmland under maize crop, number of tractors owned by farmer, number of tractor-operated implements owned by farmer, most preferred power of tractors, work output (field capacity) of ploughing operation, average fuel consumption in ploughing operation, tractor hiring cost for ploughing operation, number (diversity) of household's income-generating activities, total tractor operating cost per season and number of mechanized and non-mechanized operations.

(b) Qualitative primary data

The following qualitative data were collected and used in this study: gender, highest education attained by head of household, main occupations, main food crops grown by farmer, source of finance for farming operations, major type of soil in the area, sources of power for farm operations, makes or name of tractors owned by farmers, kinds of tractor-operated implements owned by farmers, tractor acquisition mechanisms used by farmers,

factors considered in selection of tractors and equipment, place where farmer gets repair and maintenance services, and number of mechanized operations. Other collected qualitative primary data included: place where spare parts are obtained, most preferable makes of tractor in the area, the most suitable type of plough in the area, challenges faced in provision tractor-hiring services, and farmers' opinion on the benefits of farm mechanization.

3.3.1.2 Collection of secondary data

In this study secondary data including past records on farm machinery management data and practices and policies related to agricultural mechanization development were collected through reviews of literature from various sources such as internet, journals, books, performance profiles and reports from various institutions and organizations.

(a) Tractor data

The following compiled technical data of tractors were collected for this study: tractor rated power (PTO), number of drive wheels, wheelbase, front wheel track, rear wheel track, tractor total static weight, rear static weight, front static weight, centre of gravity height from the ground, rearwards distance from rear axle to centre of gravity, vertical distance from rear axle to centre of gravity, height from the ground to rear axle. Other technical specifications of tractors compiled for this study included: lower link length, lower link maximum height, lower link minimum height, distance from rear axle to lower link hitch point, height from lower link point to rear axle, drawbar hitch height, distance from rear axle to drawbar hitch point (hitch location behind rear axle), number of speeds, maximum speed, minimum speed, recommended operating speed (no load speed), and draught angle.

(b) Tyre data

The following tyre data were collected in this study: tyre size, tyre size factor, rated capacity, section width, ply rating, overall diameter, tread code, static load radius, and star marking.

(c) Plough data

The following plough data were compiled from various sources: Tool depth (desired operating depth), spacing between soil engaging units, distance from rear axle to centre of gravity of mounted plough, maximum height from the ground to centre of gravity of a mounted plough, maximum height from rear axle to centre of gravity of a mounted plough, weight of plough, length of plough, capacity, furrow wheel diameter, number of discs, width, height, diameter of disc, working width, maximum and minimum power.

(d) Farm machinery management data

The following data were collected and compiled from various sources including Standards documents from the following organizations: American Society of Agricultural and Biological Engineers (ASABE), Organization for Economic Cooperation and Development (OECD), Centre for Agricultural Mechanization and Rural Technology (CAMARTEC), Nebraska Tractor Tests Laboratory (NTTL) International Standard Organization (ISO), Food and Agricultural Organization (FAO) and United Nations Industrial Development Organization (UNIDO). Farm machinery management data and practices extracted from these documents were: typical values for tractor performance, implement power requirements, repair and maintenance costs, depreciation, fuel and oil use, reliability for field operation, probable working days, labour, tractor, and machine costs.

3.3.2 Determining soil physical properties and terrain gradients in the study area

3.3.2.1 Introduction

The field tests were carried out on selected eight sites in Mvomero division as indicated in Fig 15. The selection of sites was purposively based on tractorization level (number of tractors), accessibility, farming systems, and terrain topography.

3.3.2.2 Determination of soil bulk density, texture and moisture content

The following equipment was used for collecting soil samples for determination of soil bulk density, texture and moisture content: Core soil sampler, Soil sample containers, Rubber mallet, Putty knives, Shovel and Polyethylene bags. Other equipment and instruments required for soil tests including Sieve and hydrometer analysis were: Balance, Set of sieves, Cleaning brush, Sieve shaker, Mixer (blender), Hydrometer, Sedimentation cylinder, Control cylinder, Thermometer, Beaker, Timing device, Electric oven, and Desiccators.

Before carrying out tractor-plough field performance trials, soil samples were collected from randomly selected three to five test locations on each plot (Appendices 1 - 8). The minimum size of the selected plots was 50m x 75m. Intact soil cores were collected from three depths: 0–5, 5–10 and 10–15 (cm) at each test location. A total of fifteen intact soil cores per plot were collected. The samples of soil were analysed for soil texture, bulk density, and moisture content in the Soil Science Laboratory of the Sokoine University of Agriculture in accordance with the standard methodology (White, 1993).

Two methods are usually used to determine soil texture i.e., the percentage of different grain sizes contained within a soil, namely mechanical/sieve analysis and hydrometer analysis methods. The mechanical or sieve analysis was performed to determine the

distribution of the coarser, larger-sized particles, and the hydrometer method was considered to determine the distribution of the finer particles as per standard of American Society for Testing Materials (ASTM), (2007).

Bulk density is an indicator of soil compaction. It is calculated as the dry weight of soil divided by its volume. This volume includes the volume of soil particles and the volume of pores among soil particles. Bulk density is typically expressed in g/cm^3 .

The standard operating procedure for Soil Bulk Density Determination involved the taking a soil sample to determine soil bulk density using the Bulk Density Soil Sampler. A gravimetric was used in which a known volume of undisturbed soil sample was dried and weighed. Thus in the laboratory, samples were carefully weighed and dried at about 105°C to a constant weight and reweighed. The result is the density for a volume of soil as it exists naturally including air space and organic matter.

Soil water content is an expression of the mass or volume of water in the soil. The basic technique for measuring soil water content is the gravimetric method. It is based on direct measurements. This method involved taking a volume of soil, accurately weighing it, completely drying it out in an oven, re-weighing the dry sample and calculating soil moisture percentage from the weight loss. The obtained values of soil texture, moisture content, and bulk density for each plot are presented in Table 21 in the results section 5.3.

3.3.2.3 Determining of soil cone index

Soil resistance to penetration (Cone index) was measured in each plot (Appendices 1- 8) using a standard penetrometer. The soil resistance data were collected from six test locations per plot. In this study the standard Cone Penetration Test (CPT) procedures

were employed (ASAE, 1998). The pressure on the handle of the penetrometer was required to force the cone into certain depths at which it is desired to determine the penetration resistance. This resistance was measured by means of the proving ring. The relationship between the load and ring deflection are linear within the elastic limit of the ring so that the penetration resistance or applied load is readily obtained from the dial indicator readings. The cone penetration method is easier in handling and cheaper than boring method, but the application range in depth is limited. The normal load was successively applied and the resistance was recorded at the interval of 5cm. In other words the cone was penetrated into the ground and the relation between the penetration depth and the penetration resistance at every point was recorded.

The soil parameter for empirical prediction of traction performance was based on the force (kN) to push a circular cone (base area 322 mm²) into the soil at a constant speed of 72 in/min (30mm/sec) (ASAE, 1998). The parameter, termed the cone index (CI) was determined by the following expression:

$$CI = \frac{\text{Force on cone}}{\text{Base area of the cone}} \quad [\text{kPa}] \quad (2)$$

The obtained values of cone index for each plot are shown in the seventh column of Table 21 in the results Section 5.3.

3.3.2.4 Determination of terrain gradients

Terrain model contains surface roughness (micro topography) and slope per cent (macro topography) variables that have influence on field performance of tractors. Calculation of ground slope is fundamental to many traditional Geographical Information Systems (GIS) applications. Various methods exist for calculating slope. Manual slope generation, based

upon contour line information, is a long established and generally accepted method (Ryder and Voyadgis, 1996). Traditional slope compilation methods are very labour intensive, requiring analysis of contour line information by a human interpreter. In the present study rapid field collection of point slope data was made possible through Global Positioning System (GPS) technology. Determination of slope data was done by using a computer which generated slope from digital elevation data. Key ingredients in this process were elevation data with adequate resolution and an algorithm that performs satisfactorily. Gradient of hill side experimental plots were determined and recorded in slope per cent. The slope data were used for analysis of the dynamics and stability of tractor-plough systems on slopes. The obtained values of slopes for each plot are presented in the last column of Table 21 in the results Section 5.3.

3.3.3 Determining field performance parameters of tractor-plough system

3.3.3.1 Introduction

The characteristics of soil and terrain conditions have substantial influences on the tractor – plough system stability and field performance factors namely; traction force, drawbar pull, implement draught, wheel slip, rolling resistance, fuel consumptions and work rate (field capacity). In this research, the collection of soil samples and measurement of field performance parameters of tractor-plough system were both carried out simultaneously.

The following instruments and equipment were used to determine the values of the field performance factors: towing tractor (NH-90HP), small tractor (towed tractor) on which measurement were made (NH-75HP), three-disc plough, mechanical dynamometer (pull type), pressure gauge, stopwatch, ruler, ranging poles, surveyor tape, towing chains, and measuring cylinder. The mechanical dynamometer was attached to the front of tractor NH-75HP. Another auxiliary tractor NH 90HP was used to pull the plough-mounted

tractor through the dynamometer. The operational parameters (i.e. disc angles, engine speed, gear ratio, and ballast and tyre inflation) were kept constant for all experimental plots. The following data were determined during the field experiments (Appendices 23-32): (a) draught force using dynamometer (b) fuel consumption using measuring cylinder (c) time taken for one run as well as time and distance covered for ten wheel revolutions with and without load using stop watch and surveyors tape respectively (d) initial and final width of tilled area using a surveyors tape (v) depth and width of cut using a ruler and a tape (vi) overall tillage time using stop watch (MAFC, 2008 and Olatunji *et al.*, 2009).

3.3.3.2 Determining implement draught force

The auxiliary tractor pulled the plough-mounted tractor in neutral gear but with the plough in the operating position and the draught force (F_w) was recorded. On the same field, the plough was lifted out of the ground and the rear tractor was pulled to record the idle draught force (F_t) (Naderi *et al.*, 2008). Draught force (D) was calculated using Equation 31.

$$D = F_w - F_t \quad (3)$$

Where:

F_w = Towing force (kN) (implement is at work)

F_t = Towing force (kN) (implement in transport position)

The obtained draught requirement for each plot is shown in Table 23 in the results Section 5.4.

3.3.3.3 Determination of rolling resistance

The tractor rolling resistance (R) was directly measured on a firm soil on each plot (Appendix 1 - 8) for specified tyre inflation pressure. The rolling resistance of the small tractor was equal to the towing force (F_d) indicated on the dynamometer when this tractor was not pulling an implement or supporting any weight. The rolling resistance (R) data was calculated by using the following expression (ASAE, 2003):

$$R = W \left(\frac{12 W}{CI \cdot b \cdot d} + 0.04 \right) \quad (4)$$

Where:

- W = Dynamic weight on wheels, (kN)
- CI = Cone Index, (ratio)
- b = Width of tyre (m)
- d = Diameter of tyre (m)

The obtained rolling resistance for each plot is shown in Table 23 in the results Section 5.4.

3.3.3.4 Determination of wheel slip

Wheels slip (S_i) represents a loss of forward motion and the associated loss of power by the tractor. It arises because the force at the wheel/surface interface causes a loss of motion i.e., the tractor does not move forward an amount equal to the amount that the wheel rotates. The wheel slip was determined during each of the drawbar pull tests by inserting pins in the ground at the start of the timed portion of the run and at the end of ten revolutions of driving wheels. The pin was inserted adjacent to a tyre rug (marked by a chalk) after ten revolutions. The Wheel Slip, S_i data were determined using the following expression (MAFC, 2008):

$$S_i = (D_e - D_a) / D_e \times 100 \quad (\%)(33)$$

Where:

D_e = Distance from ten revolutions (plough in transport position)

D_a = Actual distance from ten revolutions (plough in working position)

The obtained wheel slip for each plot is shown in Table 23 in the results Section 5.4.

3.3.3.5 Determining field capacity of tractor-plough system

To determine the rate of work (field capacity), the plot of land was marked out with minimum dimension of 75 m x 50 m. The plot was firstly ploughed (opened) from its centre with initial width of W_i and then ploughed to final width W_f . Time for one run and actual ploughing time were recorded. The ploughing operation was carried out at fixed speed (8 km/hr), and engine rpm of 2000 using the hand throttle. The depth and width of cut were also measured with a ruler and steel tape at several randomly selected places for each run.

(i) Theoretical field capacity

The theoretical field capacity, CP_t data were determined using the following relation (MAFC, 2008):

$$CP_t = W_a \times S \quad (m^2/hr) \quad (5)$$

Where:

W_a = Actual width of cut (m)

S = Ploughing speed (m/hr)

The obtained values of theoretical field capacity for each plot are shown in Table 23 in Section 5.4.

(ii) Actual field capacity

The actual (effective) field capacity (CP_a) data were determined using the following relation (MAFC, 2008):

$$CP_a = A_p \times (60/t) \quad (\text{m}^2/\text{hr}) \quad (6)$$

Where:

$$A_p = \text{Ploughed area (m}^2\text{),}$$

$$t = \text{Actual ploughing time (min.)}$$

The obtained actual field capacities for each plot are shown in Table 23 in results Section 5.4.

3.3.3.6 Determining fuel consumption

The fuel was filled to the top before starting the ploughing operation. The amount of fuel used for the entire ploughed plot was established by measuring the amount of fuel required to refill the fuel tank to the original full level. The exercise was repeated to have at least three readings and then the average was computed. The fuel consumption (F_c) data were determined using the following relation:

$$F_c = V / A \quad (\text{l/ha}) \quad (7)$$

Where:

$$V = \text{Volume of consumed fuel (litres)}$$

$$A = \text{Ploughed area (ha)}$$

The obtained fuel consumption data for each plot is shown in Table 23 in the results Section 5.4.

3.3.3.7 Determination of field efficiency

Field efficient (Fe) values were determined using the following expression

$$Fe = \frac{CP_a}{CP_t} \times 100 \quad (\%) \quad (8)$$

Where:

CP_a = Actual (effective) field capacity (m²/hr)

CP_t = Theoretical field capacity (m²/hr)

The obtained field efficiency values for each plot are shown in Table 23 in the results Section 5.4.

3.4 Data Analysis

3.4.1 Statistical analysis of agricultural mechanization data

The data collected from the study area on the situation of agricultural mechanization were coded, entered, and cross-checked for accuracy, verified and analysed using the Statistical Package for Social Scientists (SPSS) computer programme SPSS v. 11.5 (2002) to determine frequency of responses and the average of each response. The ratios of respondents in different categories of questionnaire were determined and put into appropriate table for further analysis. No statistical analyses were performed on the responses from farm machinery dealers, extension workers and tractor operators. Their questionnaires were meant to gather knowledge on the prevailing perceptions from them on the topics like: current level of farm mechanization, constraints and mechanization factors, type and size of most suitable farm equipment and farmers' preferences regarding use of farm equipment. The analysis results are presented in Table 2 through Table 20 in the results Section 5.2.

3.4.2 Determining agricultural mechanization status

An indicator of agricultural mechanization is a variable that allows describing and monitoring the processes, status and tendencies of systems at the farm, village, ward, and district levels as well as at the regional, national or worldwide levels. Evaluation of farm mechanization was made with a set of appropriate evaluating indicators. The commonly used indicators include mechanization index (MI), level of mechanization (LOM) and mechanization degree (MD). A part of the present research was the formulation of indicators (MD, MI and LOM) to measure the mechanization status achieved at the district level. During the interviews, data were recorded on all the mechanized operations performed by farmers in the sample providing an estimation of the field capacity. Field capacity was multiplied by rated power so that the quantification of energy expenditure in kW-h was made in work units.

3.4.2.1 Calculation of degree of mechanization

Degree of mechanization (MD) is the ratio of the mechanized operations to the total operations. Sharabiani and Ranjbar (2008) defined the degree of mechanization as the ratio of accomplished mechanization area to the required one. It is a basic indicator which can be used for calculating the development of mechanization. To calculate the degree of mechanization in the division of Mvomero, Equation 38 was used:

$$DM = \frac{S_m}{S_t} \quad (9)$$

Where:

MD= mechanization degree

S_m = area under the mechanized operations (ha)

S_t = total area under cultivation (ha)

3.4.2.2 Calculation of level of mechanization

The Level of mechanization is based on the premise that a mechanized farmer is one who finds a way to utilize amounts of mechanical energy that are higher than typical values using locally available technologies (human and animal energy) (Olaoye and Rotimi, 2010). The level of mechanization was calculated by using Equation 39:

$$\text{LOM} = \frac{\text{AP}}{\text{TCA}} \quad (10)$$

Where:

LOM = Level of mechanization (kW/ha)

AP = Actual total power of existing tractors (kW)

TCA = Total cultivated area by human beings, traction animals and tractors (ha)

The actual total power of existing tractors (kW) is calculated by the use of Equation 40:

$$\text{AP} = \text{RP}_{\text{av}} \times \text{Nt} \times \text{C} \quad (11)$$

Where:

RP_{av} = Average Rated Power of one tractor (kW)

Nt = Number of working tractors

C = Coefficient for the conversion of rated power into drawbar power (0.75)

(Olaoye and Rotimi, 2010).

3.4.2.3 Calculation of mechanization index

The Mechanization Index (MI) elaborated here is an expression of the deviation of the actual amount of motorized farm work from the mean values at the district level (Olaoye and Rotimi, 2010). This index is also based on the premise that a mechanized farmer is one who finds a way to utilize amounts of mechanical energy that are higher than the typical values using locally available technologies. Mechanization index is expressed by the percentage of machine work to the sum of manual, animal and machine work expressed in energy units using Equation 41:

$$I_E = \frac{E_M}{E_H + E_A + E_M} \quad (41)$$

Where:

I_E = Mechanization index

E_M = machine work

E_H = manual work

E_A = animal work

In the present study Equation 41 was adopted to estimate a mechanization index in Mvomero district, based on the matrix of use of human, draught animal and mechanical energy inputs.

3.4.3 Statistical analysis of soil characteristics data

The soil and terrain physical properties including bulk density, moisture content, texture cone index and slope gradient collected from the study area were analysed using Statistical Package for Social Science, SPSS v. 11.5 (2002), to determine their minimum, maximum and mean values as well as their standard deviations. The analysis results are presented in Table 22 in the results Section 5.3.

3.4.4 Statistical analysis of field performance data of tractor-plough system

The field operating and performance parameters including depth of cut, width of cut, wheel slip, draught force, draught power, fuel consumption, rolling resistance, theoretical field capacity, actual field capacity, field Efficiency, and field efficiency collected from the study area were analysed using Statistical Package for Social Science SPSS v. 11.5 (2002) to determine their minimum, maximum and mean values as well as their standard deviations. The analysis results are presented in Table 24 in the results Section 5.4.

3.4.5 Developing regression models for predicting tractor-plough system's field performance parameters

3.4.5.1 Introduction

In this section the interest lied in regression analysis i.e., examining how one variable relates to a number of other variables or predicting one variable from others. According to Landau and Everitt (2004) multiple-linear regression is a method of analysis for assessing the strength of the relationship between each of a set of explanatory variables (or independent variables) and a single response (or dependent) variable.

For each model, the following statistics were of concern: regression coefficients, correlation matrix, part and partial correlations, multiple R , R^2 , adjusted R^2 , change in R^2 , standard error of the estimate, analysis-of-variance table, predicted values, and residuals. Other statistics considered are: 99%, 95% and 90%-confidence intervals for each regression coefficient, variance-covariance matrix, variance inflation factor and tolerance. Co-linearity diagnostics were tested in order to detect whether there is correlation among the independent (X_n) variables.

Using SPSS software Version 11.5 (2002), regression models were run to quantify the effect of the factors (independent variables) contributing to the fuel consumption and draught power. The models were also run to gauge the role of each variable in explaining the variances in the dependent variable.

3.4.5.2 Regression models for predicting draught power

The specification of multiple linear regression models for draught power is presented in the Equation 42. Variables and constants in the regression model are defined as follows: X_1 to X_n = independent variables, β_1 to β_n = standardized partial regression coefficients for

independent variables, a = Intercept (constant) term and, ε = random error term (Franklin and Walker, 2010).

$$Y_{dp} = a + \beta_1 X_1 + \beta_2 X_2 + \beta_3 X_3 + \beta_4 X_4 + \dots + \beta_n X_n + \varepsilon \quad (12)$$

Where:

Y_{dp}	=	Dependent variable representing draught power
X_1	=	Moisture content
X_2	=	cone index
X_3	=	width of cut
X_4	=	depth of cut
X_5	=	draught force,
X_6	=	rolling resistance
X_7	=	working speed

The regression results are presented in the results Section 5.5.2, Equation 71.

3.4.5.3 Regression models for predicting fuel consumption

The specification of multiple linear regression models for fuel consumption is presented in the Equation 43. Variables and constants in the regression model are defined as follows: X_1 to X_n = independent variables, β_1 to β_n = standardized partial regression coefficients for independent variables, a = Intercept (constant) term and, ε = random error term (Franklin and Walker, 2010).

$$Y_{fc} = a + \beta_1 X_1 + \beta_2 X_2 + \beta_3 X_3 + \beta_4 X_4 + \dots + \beta_n X_n + \varepsilon \quad (13)$$

Where:

Y_{fc}	=	the dependent variable representing fuel consumption.
X_1	=	Moisture content
X_2	=	cone index

- X_3 = width of cut
 X_4 = depth of cut
 X_5 = draught force,
 X_6 = rolling resistance
 X_7 = working speed

The regression results are presented in the results Section 5.5.3, Equation 72.

CHAPTER FOUR

4.0 DEVELOPMENT OF SIMULATION MODELS FOR PREDICTING STATIC STABILITY OF TRACTOR–PLOUGH SYSTEM ON SLOPING TERRAIN

4.1 Introduction

Research into tractor stability based on computer simulation is considered as one of the most powerful methods for the study of tractor stability and dynamics (Yisa and Terao, 1995). Computer simulation models depending on the parameters considered are either static, quasi-static or dynamic. In this study the analysis of tractor – plough stability on the sloping land was based on static models. Improved static stability is directly proportional to improved dynamic stability (Demsar *et al.*, 2012). Under static conditions a tractor will lose stability and start to overturn when the normal to ground component of a wheel load becomes zero.

The purpose of this chapter, therefore, is to present the procedure used for the analysis of static stability of Tractor-Plough System (TPS) operated on agricultural sloping land through computer simulations with the objective of explaining the rearwards, sideways and overall static overturning stability limits. The static overturning stability limits determined here were used as criteria for selection of optimum tractor-plough system operated on sloping agricultural lands. In the next sections the procedure used for the development of the models and the computer simulation are presented.

The analysis was based on the following assumptions: (a) a rear wheel drive tractor (2WD) in combination with a plough was considered in this study (Fig. 15 and 16). (b) Tractor rigid body; (c) Tractor is symmetrical with respect to a plane perpendicular to the

rear axle and passing through its mid-point; (d) Dynamic properties are represented by the tractor mass, moments and products of inertia; (e) Line of action of the drawbar pull is located midway between the traction wheels and parallel to the direction of motion; (f) Lines of action of the normal ground reaction pass through the centre of wheels and wheel ground reaction act at a single ground contact point at each wheel; (g) Lines of action of the traction force and rolling resistance are tangential to the wheels; (h) Terrain surface is non-deformable and (i) Terrain surface is planar.

4.2 Developing Simulation Model for Predicting Rearwards Static Overturning Stability of Tractor-Plough System in Uphill Steady Motion

Summation of forces parallel to the direction of motion as illustrated in Fig. 16 is given by:

$$F_t - R_f - R_r - W_t \sin \beta - (W_t + W_p/g) \alpha_h - W_p \sin \beta = 0 \quad (1)$$

Where:

α_h	=	horizontal acceleration
α_v	=	Vertical acceleration
β	=	slope angle
g	=	gravity

Where:

F_t = Total net traction forces developed by rear wheels, R_f = Rolling resistance on the front wheels, R_r = Rolling resistance on the rear wheels, W_t = Weight of tractor, W_p = Weight of plough, of the centre of gravity in the direction of motion, β = Slope angle, N_f = Soil reaction against front wheels of the tractor, X_r = Distance from the rear axle to the centre of gravity of tractor, N_r = Soil reaction against the rear wheel of the tractor, X_g = Distance from the rear axle to the centre of gravity of the plough, h_p = Height of the centre of gravity of plough above the ground, X = wheelbase.

expression of RSOSL of tractor- plough system in transport position on slope is given by Equation 47:

$$RSOSL = \frac{W_t \times X_r + W_p \times X_g}{W_t \times h_t + W_p \times h_p} \geq \tan\beta. \quad (4)$$

Where:

W_t = tractor weight, W_p = plough weight, X = wheel base, h_t = height of centre of gravity of tractor above the ground, h_p = height of centre of gravity of plough above the ground, X_r = distance from the rear axle to the centre of gravity of tractor and X_g = distance from the rear axle to the centre of gravity of the plough.

4.2.1 Modelling the influence of design parameters on rearwards static stability of tractor –plough system

The design parameters in Equation 47 have different effects on rearwards static overturning stability limit of tractor-plough system on slopes. Solving for W_t , X_r , W_p , h_t , h_p , and X_g in the RSOSL Equation 47, the following simulation models for predicting the influence of each design parameter were obtained:

$$W_t \geq W_p \frac{(X_g + h_p \tan\beta)}{(X_r - h_t \tan\beta)} \quad (5)$$

$$W_p \leq W_t \frac{(X_r - h_t \tan\beta)}{(X_g + h_p \tan\beta)} \quad (6)$$

$$X_r \geq \frac{(W_t h_t + W_p h_p) \tan\beta + W_p X_g}{W_t} \quad (7)$$

$$X_g \leq \frac{W_t X_r - (W_t h_t + W_p h_p) \tan\beta}{W_p} \quad (8)$$

$$h_t \leq \frac{W_t X_r - W_p (X_g - h_p \tan\beta)}{W_t \tan\beta} \quad (9)$$

$$h_p \leq \frac{W_t (X_r - h_t \tan\beta) - W_p X_g}{W_p \tan\beta} \quad (10)$$

4.3 Developing Simulation Model for Predicting Sideways Static Overturning Stability of Tractor-Plough System Operated Across the Slope

Summation of sideways forces in transport position across the slope illustrated in Fig. 17 is given by Equation 54.

$$(W_t + W_p) \times \sin \beta - L_d - L_u - ((W_t + W_p)/g) \times \alpha_h = 0 \quad (11)$$

Summation of moments about point B is given by:

$$R_u \times Z_t + W_t \times \sin \beta \times h_t + W_p \times \sin \beta \times h_p - \\ - W_t \times \cos \beta \times 0.5Z_t - W_p \times \cos \beta \times 0.5Z_t = 0 \quad (55)$$

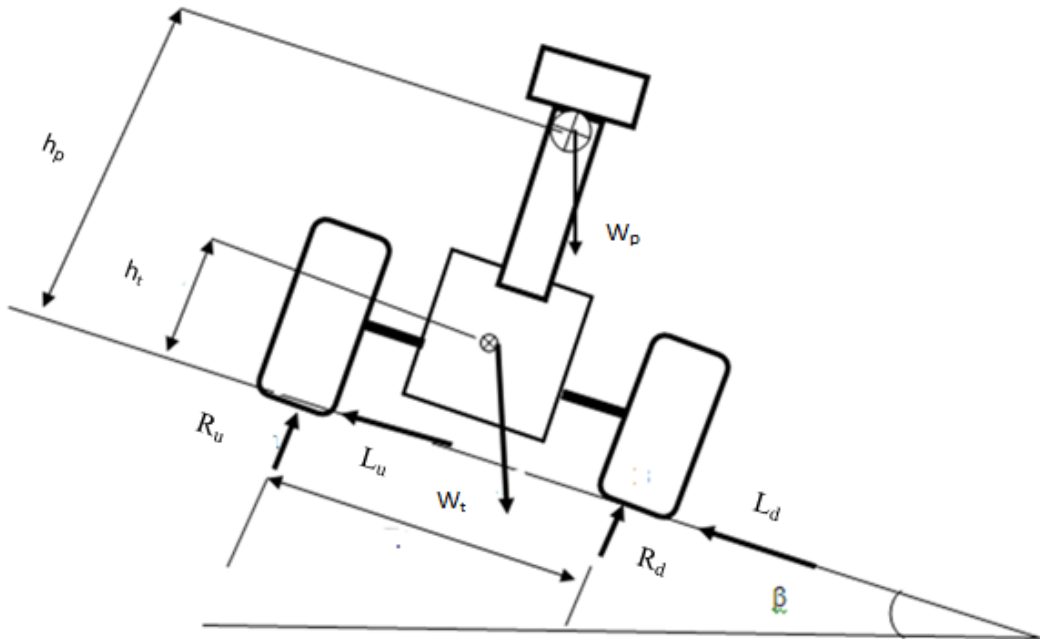

Figure 17: Forces acting on tractor-plough system in transport position - motion across the slope.

R_u = Soil reaction against upper-side wheels, Z_t = Wheel track, h_t = Height of centre of gravity of tractor above the ground, h_p = Height of the centre of gravity of plough above

the ground, L_u = sideways force acting on the upper side wheels, L_d = sideways force acting on the down side wheels.

The stability to sideways overturning of the system is given by the condition that the soil reaction against upper-side wheels of the tractor is greater than zero i.e. $R_u \geq 0$). In this condition, the obtained expression of Static Sideways Overturning Stability Limit (SSOSL) of tractor- plough system in transport position across the slope is given by Equation 56:

$$SSOSL = \frac{0.5 \times Z_t (W_t + W_p)}{(W_t \times h_t + W_p \times h_p)} \geq \tan \beta \quad (12)$$

Where:

W_t = tractor weight, W_p = plough weight, h_t = height of centre of gravity of tractor above the ground, h_p = height of centre of gravity of plough above the ground, Z_t = wheel track.

4.3.1 Modelling the influence of design features on sideways static overturning stability of tractor –plough system

The design parameters in Equation 56 have different effects on sideways static overturning stability of tractor-plough system on slopes. Solving for W_t , W_p , h , h_p , and Z_t in the SSOSL Equation 56, the following simulation model for predicting the effects of design parameters on sideways static overturning stability of tractor- plough system were obtained:

$$W_t \geq W_p \frac{(0.5 \times Z_t + h_p \times \tan \beta)}{(0.5 \times Z_t - h_p \times \tan \beta)} \quad (13)$$

$$W_p \leq W_t \frac{(0.5 \times Z_t - h_t \times \tan \beta)}{(0.5 \times Z_t + h_t \times \tan \beta)} \quad (14)$$

$$Z_t \geq \frac{(W_t \times h_t + W_p \times h_p) \tan \beta}{0.5(W_t + W_p)} \quad (15)$$

$$h_t \leq \frac{0.5Z_t W_t + W_p(0.5X Z_t - h_p \tan\beta)}{W_t \tan\beta} \quad (16)$$

$$h_p \leq \frac{W_t(0.5Z_t - h_t \tan\beta) + 0.5Z_t W_p}{W_p \tan\beta} \quad (17)$$

4.4 Developing Simulation Model for Predicting the Overall Static Overturning Stability of Tractor-Plough System on Slope

The overall (rearwards and sideways) stability of the tractor-plough combination was determined by treating Equations 47 and 56 simultaneously. The Overall Static Overturning Stability Limit (OSOSL) simulation model presented as Equation 62 was obtained:

$$\text{OSOSL} = \frac{W_t(X_t + 0.5Z_t) - W_p(X_g - 0.5Z_t)}{2(W_t h_t + W_p h_p)} \geq \tan\beta \quad (18)$$

Where:

W_t = tractor weight, W_p = plough weight, X = wheel base, X_t = horizontal distance from rear axle to centre of gravity of tractor, h_t = height of centre of gravity of tractor above the ground, X_g = horizontal distance from rear axle to centre of gravity of plough, h_p = height of centre of gravity of plough above the ground, Z_t = wheel track.

4.5 Simulation of Effects of Design Parameters on Static Overturning Stability of Tractor-Plough System

A computer simulation was carried out to investigate the effects of design features on rearwards and sideways overturning stability of tractor – plough system operating on slopes. The following design features were involved in the simulation: tractor weight (W_t), plough weight (W_p), wheel base (X), horizontal distance from rear axle to centre of gravity of tractor (X_t), height of centre of gravity of tractor above the ground (h_t), horizontal distance from rear axle to centre of gravity of plough (X_g), height of centre of gravity of plough above the ground (h_p), wheel track (Z_t).

4.5.1 Determining centre of gravity of tractor and plough

The Centre of Gravity (C.G.) of a body is a point of application of the gravitational force acting upon it i.e. the point where the weight of the body is located or concentrated.

(a) The centre of gravity of tractor

The centre of gravity of tractor is the point at which the whole of the mass and the weight of tractor may be considered to act. The C.G. of tractor is usually specified in relation to rear axle (Macmillan, 2002). The geometry of position of C.G is determined in two locations: horizontal location (X_r) and vertical location (h_t). In this study horizontal location (X_r) was calculated using the Equation 57 (Macmillan, 2002).

$$X_r = \left(\frac{w_f}{W_t} \right) X \quad (19)$$

Where:

- X_r = horizontal distance from the rear axle to the C.G
- X = wheel base (given in the manufacturer specifications)
- w_f = static front weight of tractor
- W_t = static weight of tractor

The vertical location of C.G of tractor was determined using the Equation 64(Macmillan, 2002).

$$dt/(ht) = \lambda \quad (20)$$

Where:

- dt = tractor drawbar height (given in manufacturer specifications)
- ht = tractor C.G. height
- λ = ratio (typical value = 0.6) (Macmillan, 2002)

(b) Centre of gravity of plough

The centre of gravity of the plough was determined through experiment using plumb line, marker pen, engine hoist stand and paper tape. The plough was hanged from one point and the plumb line was dropped from the same point. A line was drawn on the plough along the string using marker pen. The procedure was repeated from another point on the plough. The point of intersection of two lines drawn on the plough marked the centre of gravity of the plough.

4.5.2 Simulation algorithm

The translation of mathematical models described in Section 4.2 and 4.3 into Visual Basic (VB 6) programme was carried out in accordance with the flow chart presented in Fig. 18. Slope angle was varied in several equal steps. The data used for stability analysis were obtained from Massey Ferguson (MF491) tractor with the following technical specifications and design features:

Power	PTO = 55 kW
Weight of tractor	W_{to} = 33.86 kN
Wheel base of the tractor	X_o = 2.29 m
Dimension from the rear axle to the centre of gravity of tractor	X_{ro} = 2.24 m.
Horizontal dimension from rear axle to c.g. of mounted plough	X_{go} = 3.01m.
Height of centre of gravity of tractor above the ground	h_{to} = 0.76 m.
Height of centre of gravity of mounted plough	h_{po} = 1.63 m.
Specifications of the disc plough (Alvan Blanch ADP3) are:	
Plough length	L_{po} = 2.13 m
Plough weight	$w_{t_{po}}$ = 3.9 kN

Maximum work width	$w_c = 0.99 \text{ m}$
Maximum work depth	$d_c = 25 \text{ cm}$
Number of discs	$n_d = 3$
Disc diameter	$D = 0.66 \text{ m}$
Furrow wheel diameter	$f_d = 0.51 \text{ m}$

Simulation results of the rearwards and sideways static overturning stability are presented in Table 27 and Table 28 respectively in the results Section 5.6.2.

4.5.3 Testing tractors for slope capability in the study area

Determination of stability of a tractor on slopes has been done in different ways. The stability of tractor on slope may be expressed in terms of Stability Index (SI) (Ahmadi, 2011). Stability index is defined as minimum slope on which a dynamic test causes a tractor to tip halfway towards overturning. A tractor with big stability index will be more stable than the one with small stability index (Yisa and Terao, 1995). In this study rearwards and sideways static overturning stability indices (limits) for twenty tractors were predicted and tested for their slope capability on three sites in Mvomero I MvomeroII and Hambeti with slope angles of 16° , 10° , and 7° respectively. Results of the predicted rearwards and sideways static overturning stability and test for slope capability are presented in Table 29 and Table 30 respectively in the results Section 5.6.4.

4.6 Developing regression models for predicting tractor-plough system's static overturning stability

4.6.1 Introduction

In this section the interest lied in regression analysis i.e. examining how one variable relates to a number of other variables or predicting one variable from others. According to Landau and Everitt (2004) multiple-linear regression is a method of analysis for assessing

the strength of the relationship between each of a set of explanatory variables (or independent variables) and a single response (or dependent) variable. For each model, the following statistics were of concern: regression coefficients, correlation matrix, part and partial correlations, multiple R , R^2 , adjusted R^2 , change in R^2 , standard error of the estimate, analysis-of-variance table, predicted values, and residuals.

Other statistics considered are: 99%, 95% and 90%-confidence intervals for each regression coefficient, variance-covariance matrix, variance inflation factor, tolerance. Collinearity diagnostics were tested in order to detect whether there is correlation among the independent (X_n) variables.

4.6.2 Regression models for predicting rearwards static overturning stability of tractor-plough system

Using SPSS software, linear regression models were run to quantify the effect of the factors contributing to the rearwards stability as independent variables as well as to gauge the role of each variable in explaining the variances in the dependent variable. The specification of multiple linear regression models was as follows (Landau and Everitt 2004):

$$Y_{rs} = a + \beta_1 X_1 + \beta_2 X_2 + \beta_3 X_3 + \beta_4 X_4 + \dots + \beta_n X_n + \varepsilon \quad (21)$$

Where:

Y_{rs} = Dependent variable representing rearwards stability.

X_1 = Horizontal dimension from rear axle to CG of plough

X_2 = Weight of mounted plough

X_3 = Tractor Weight

X_4 = Horizontal distance from rear axle to CG of tractor

X_5 = Height of CG of plough

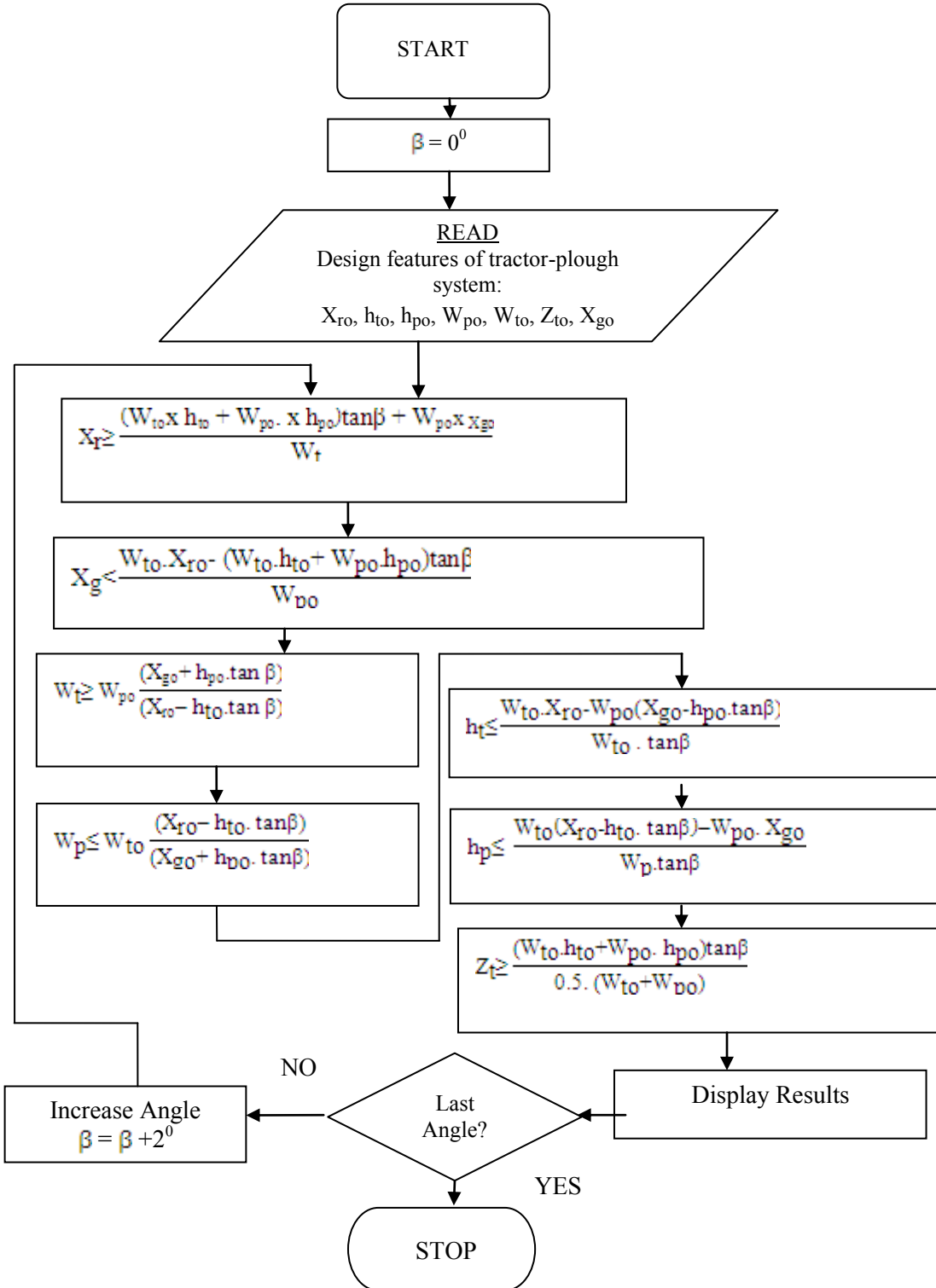

Figure 18: Flow chart of static stability simulation program.

4.6.3 Regression model for predicting sideways static overturning stability

Using SPSS software, simple and multiple linear regression models were run to quantify the effect of the factors contributing to the sideways stability as independent variables as well as to gauge the role of each variable in explaining the variances in the dependent variable. The specification of multiple linear regression models was as follows (Landau and Everitt 2004):

$$Y_{ss} = a + \beta_1 X_1 + \beta_2 X_2 + \beta_3 X_3 + \dots + \beta_n X_n + \varepsilon \quad (22)$$

Where:

Y_{ss} = Dependent variable representing sideways stability

X_1 = Tractor Weight (kN)

X_2 = Height of Tractor CG (m)

X_3 = Average Wheel Track (m)

X_4 = Height of CG of lifted plough (m)

4.6.4 Regression analysis of effects of design parameters on static stability of tractor-plough system

In the analysis of simulated data concerning the influence of design features of tractor and plough on static stability, curve estimation procedure was used to produce curve estimation regression statistics and related plots. For each model the following statistics were considered (Landau and Everitt 2004): regression coefficients, multiple R, R^2 , adjusted R^2 , standard error of the estimate, analysis-of-variance table, predicted values, residuals, and prediction intervals. The following curve estimation regression models were chosen:

Linear equation: $Y = \beta_0 + \beta_1 X + \varepsilon \quad (23)$

$$\text{Quadratic equation: } Y = \beta_0 + \beta_1 X + \beta_2 X^2 + \varepsilon \quad (24)$$

$$\text{Inverse equation: } Y = \beta_0 + (\beta_1 / X) + \varepsilon \quad (25)$$

$$\text{Cubic equation: } Y = \beta_0 + \beta_1 X + \beta_2 X^2 + \beta_3 X^3 + \varepsilon \quad (26)$$

4.7 Developing a Computer Decision Support Tool for Selecting Optimum Tractor-Plough System

4.7.1 Introduction

In selection of farm machinery, different optimization techniques have been used. According to Dash and Sirohi (2008) such techniques include linear programming (LP), integer programming, mixed integer linear programming, and least cost. Dash and Sirohi (2008) carried out a critical evaluation of the optimization techniques to identify their limitations. The least-cost method was found to be comparatively effective and convenient.

In the present study, the least-cost method was chosen and employed in optimizing the selection of farm tractor power and plough width for different farm sizes and allotted time. Thus, the Tractor-Plough System Selection Tool (TPSST) was developed to satisfy the requirements related to field performance parameters, static overturning stability, and total annual costs. Annual tractor and plough costs were based on initial prices of tractor and plough as well as technical feasibility of the tractor and plough sources.

Technical feasibility is determined by draught force, drawbar pull, and static overturning stability as well as ground speed, capacity in hectare per hour, time requirements and allotted time (Osborn and Barrick, 1970). Each tractor was capable of developing a specific drawbar pull at specified speeds and each plough had specified draught force and speed requirements (Al-Hamed and Al-Janobi, 2001).

Each selected tractor-plough system satisfied the requirement of static overturning limit for specified slope.

The selection was designed to begin with the smaller tractor and largest plough. As shown in the flow chart in Fig. 22 - 26, if the tractor's drawbar pull was less than the draught requirement of the plough, the smaller plough was selected. However, if the selected tractor did not develop sufficient drawbar pull to satisfy the draught requirement of any plough size and time constraint, larger tractor was selected. In addition, the selected tractor-plough system was required to satisfy, the newly introduced in this study, criterion of static overturning stability limit, otherwise stable system was selected. For each selection which meets the above requirements, fixed and variable costs were determined (Schuler, 2006). Then, other tractor and equipment sizes were evaluated to select the least-cost system.

4.7.2 Establishing equations and algorithm for computer program development

4.7.2.1 Equations used for computer program development

The algorithm for the selection of optimum tractor – implement combination within the constraints of farm size, allotted time, terrain and soil characteristics etc. was developed from different mathematical equations described in the next sections. An algorithm describes how the data is to be processed to produce the desired output (Bronson and Rosenthal, 2005). The developed computer algorithm (processing steps) using pseudo code and the flow charts are presented in Fig. 21 and Fig. 22-26 respectively.

(a) Equations for predicting traction performance

Assumptions

- (i) The radial tyre traction coefficient values used are those recommended by Brixius (1987) for the traction prediction equations.
- (ii) The tyre deflection is 20 percent of the un-deflected section height (ASAE, 2003).
- (iii) Cone index is the same for front and rear tyres.

The traction prediction equations of Brixius (1987) were adopted and used in the development of computer program for selection optimum tractor-plough system. The program used a general form of the Brixius equations where the Gross Traction Ratio (GTR), Motion Resistance Ratio (MRR) and Net Traction Ratio (NTR) are as expressed and described in Section 2.3.2 Equations 9 – 12.

(b) Equation for calculating draught force and power

Implement draught and power requirement are calculated using equations adopted from ASAE (2003). The Equation for calculating draught is given in the literature review chapter Section 2.3.3, Equation 13. The multiple regression models for estimating draught power developed in Section 3.4.5.2 which are presented in the in the results Section 5.5.2 (Equation 27) were also used to develop computer program for selection of optimum tractor-plough system.

(c) Equations for estimation of fuel consumption

In this study, equations used for estimation of average annual fuel consumption, Q_{ave} and specific volumetric fuel consumption, SVFC were adopted from ASAE (2003). They are discussed in the literature review chapter Section 2.3.4, Equation 14 and 15. Regression models for prediction of fuel consumption developed in Section 3.4.5.3 and presented in

the in the results Section 5.5.3 (Equation 28) were also used to develop computer program for selection of optimum tractor-plough system.

(d) Models for predicting static overturning stability limits

The mathematical models, developed in Sections 4.2 through 4.6.4 for predicting rearwards, sideways and overall static stability, were also used to develop computer program for selection of optimum tractor-plough system.

(e) Equations for estimation of farm tractor-plough system annual costs

The objective was to select tractor and plough in the size range where total tractor and plough costs are lowest. The annual cost of each tractor-plough combination was estimated by the Equation 28 established in Section 2.5.1.

The requirements for the program were organized into modules in accordance with the adopted and modified structure diagram of Bronson and Rosenthal (2005), and the flow diagram of Al-Hamed and Al-Janobi (2001) presented in Fig.19 and Fig. 20 respectively. Analysis was carried out to ensure that the problem at hand is clearly defined and understood in terms of: (a) what the system must do (b) what reports or outputs must be produced and (c) what input is required to create the desired output (Bronson and Rosenthal, 2005).

The computer program design had to ensure that the program selects the matched tractor and plough that would maximize static overturning stability on specified slope and minimize the total annual costs. Annual tractor and plough costs included fuel, oil, maintenance, labour, and depreciation costs. Input of the model included the farm area, allotted time (days), average working hours per day, ground speed, terrain slope, soil cone

index, soil texture, traction surface condition, fuel price, and labour (wage) cost. Output of the model included the number, sizes, models and identity numbers of all tractors selected; ploughs, hours of use, drawbar pull, plough draught, fuel consumption, field capacity and tractor and plough annual costs (Osborn and Barrick 1970).

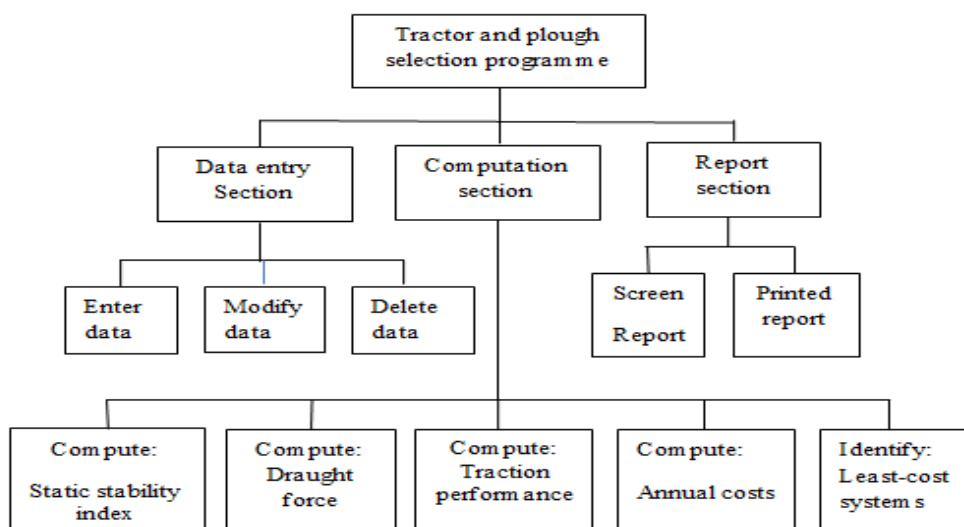

Figure 19: Structure diagram for the tractor - plough system selection tool.

Adopted and modified structure diagram of Bronson and Rosenthal (2005)

4.7.3 Computer program development

4.7.3.1 Introduction

Programming the solution involved translating the chosen design solution into computer program. A flexible, object oriented, event driven and user friendly application program was needed for performance prediction and selecting optimum tractor-plough systems. Visual Basic programming language was chosen for developing graphical user interfaces (GUIs). Thus, a program written in Visual Basic (VB) programming language was developed specifically for this purpose.

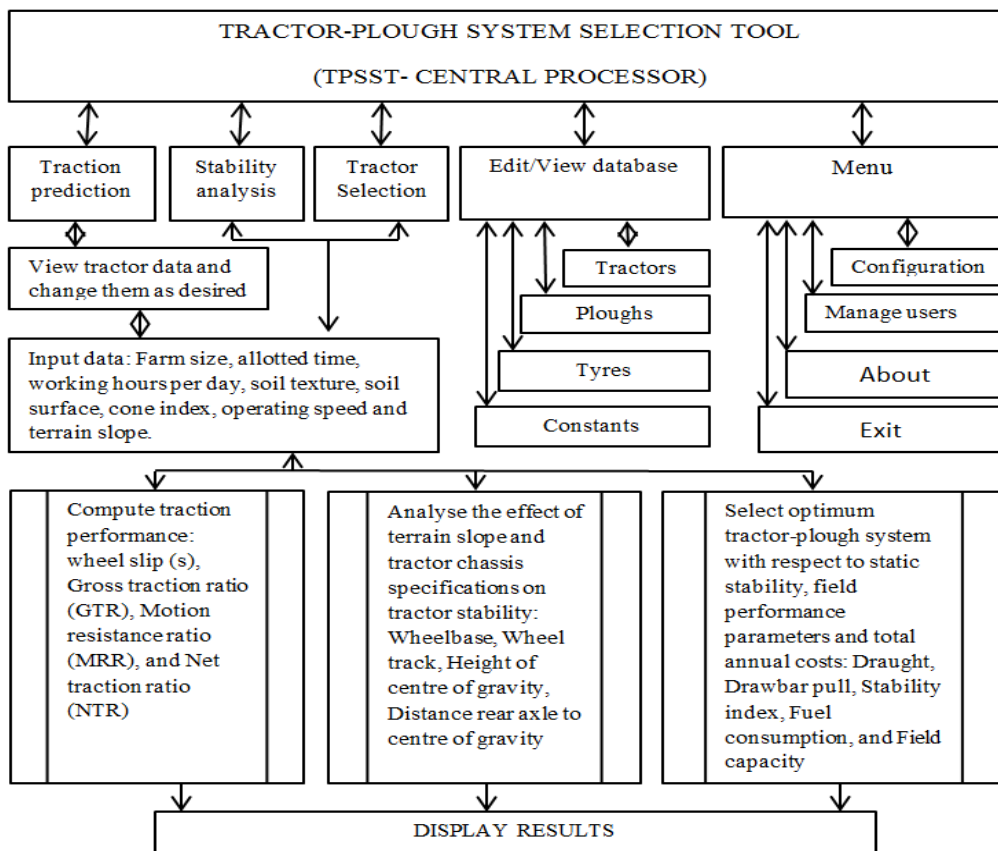

Figure 20: Flow diagram of tractor and plough selection program.

Adopted and modified from Al-Hamed and Al-Janobi (2001)

Visual Basic is an object oriented language which is focused on the user and his interaction with the program (Bronson and Rosenthal, 2005). In application it is the user who controls the flow by actions through GUI, normally by the mouse or keyboard. The user of this programme will not need special advanced training rather general computer literacy will be the minimum requirement. VB contains classes which have methods and properties that can perform operations and set attributes in the object. VB works with three components: classes, modules and forms.

1. START
2. Select plough, begin with largest size available
3. Select tractor, begin with smallest size available
4. Calculate tractor drawbar pull
5. Calculate implement draught force
6. Calculate Overall Static Overturning Stability (OSOSL)
7. Check if the tractor's drawbar pull is greater than the draught of the plough.
8. If true, check if OSOSL is greater than tangent slope angle ($\tan\beta$).
9. If true check if equipment capacity sufficient to complete job in allotted time.
10. If true calculate costs for implement and tractor selected
11. If false, check if a larger is available
12. If true select next larger tractor
13. If false calculate number of hectares remaining
14. If false select other equipment-go to beginning.
15. If false, check if smaller plough is available
16. If true select next smaller plough
17. If false select next larger tractor
18. Store the equipment selected
19. Check if all hectares have been worked
20. If true, sum costs for the operation
21. If false go to the beginning select equipment to finish operation
22. Check if the costs are less than with previous equipment size
23. If true, store tractor and plough selected
24. If false, check if smaller plough is available
25. If true, select next smaller plough
26. If false calculate total annual cost
27. Check if this is the first system developed.
28. If true, store data for current system
29. If false, check if total annual cost of current system is less than TAC of previous system
30. If true store data for the current
31. If false, check if the system contains more than one tractor.
32. If true, check if smaller tractor is available
33. If true limit tractors to the next smaller size-go to the beginning
34. If false print data for least cost system
35. If false, check if largest tractor available has been considered
36. If false choose next larger tractor-go to the beginning
37. If true print data
38. STOP
39. END

Figure 21: Pseudo code for selecting optimum tractor-plough system.

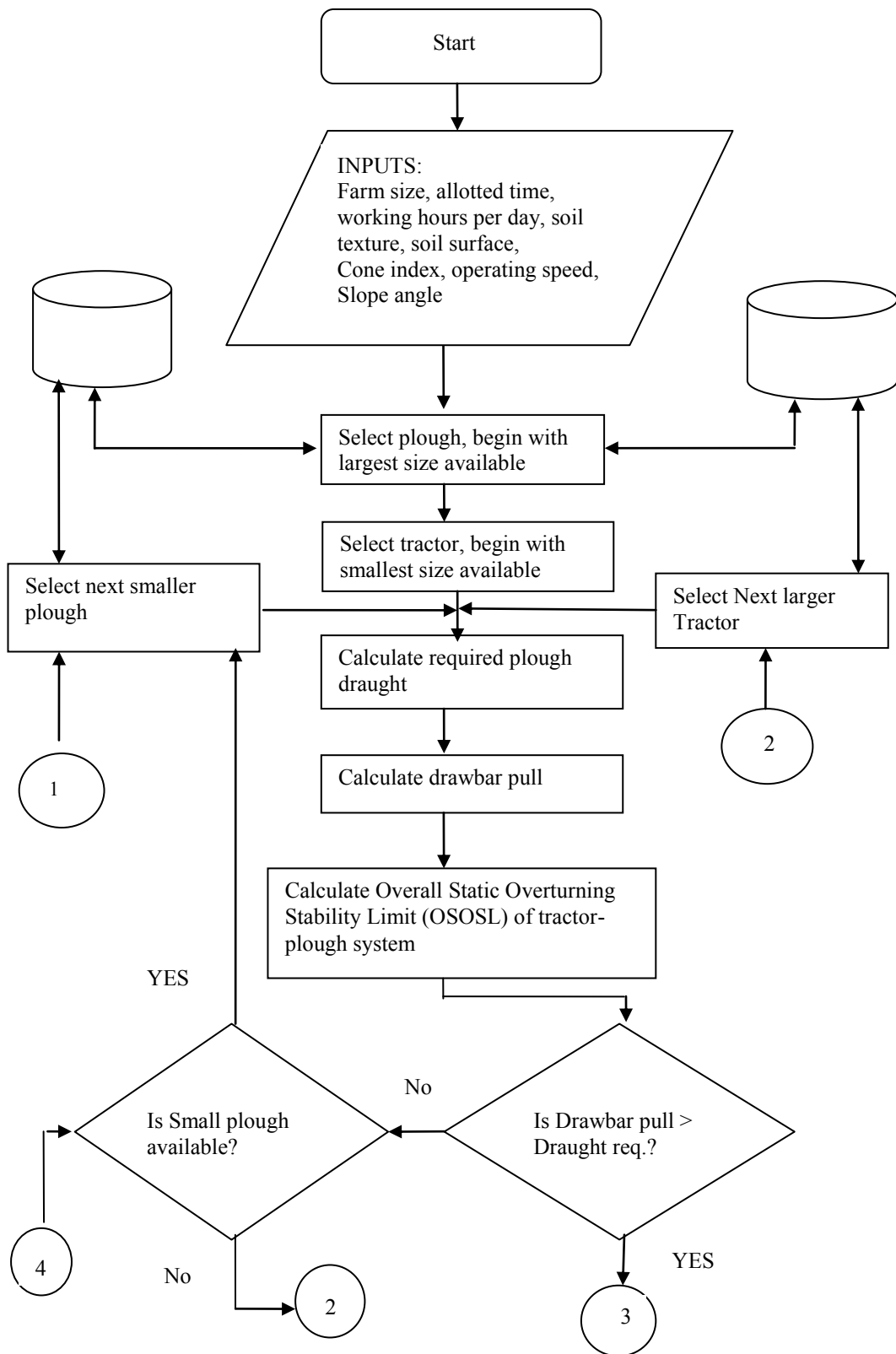

Figure 22: Flow chart A for selection of optimum tractor-plough system.

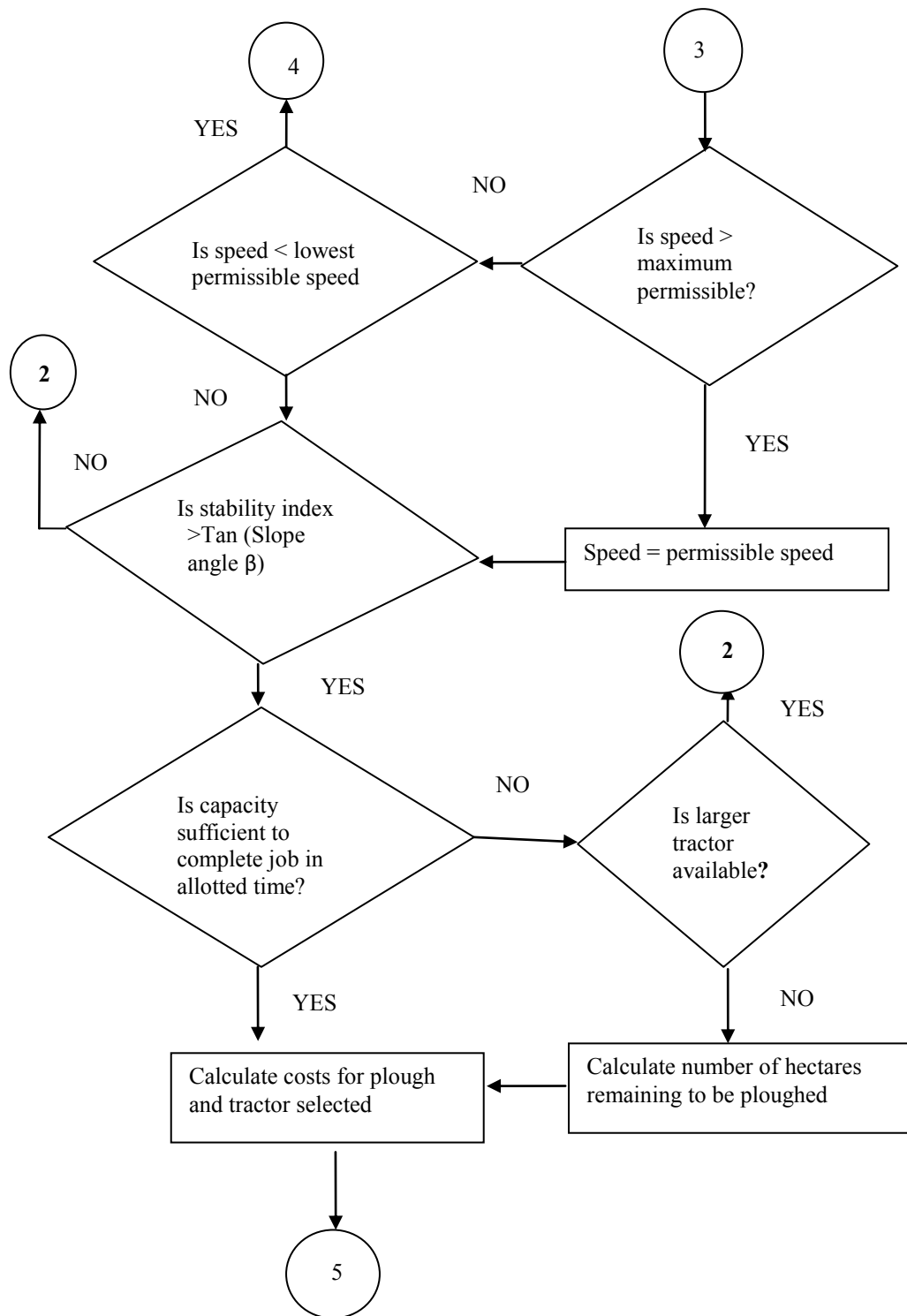

Figure 23: Flow chart B for selection of optimum tractor-plough system.

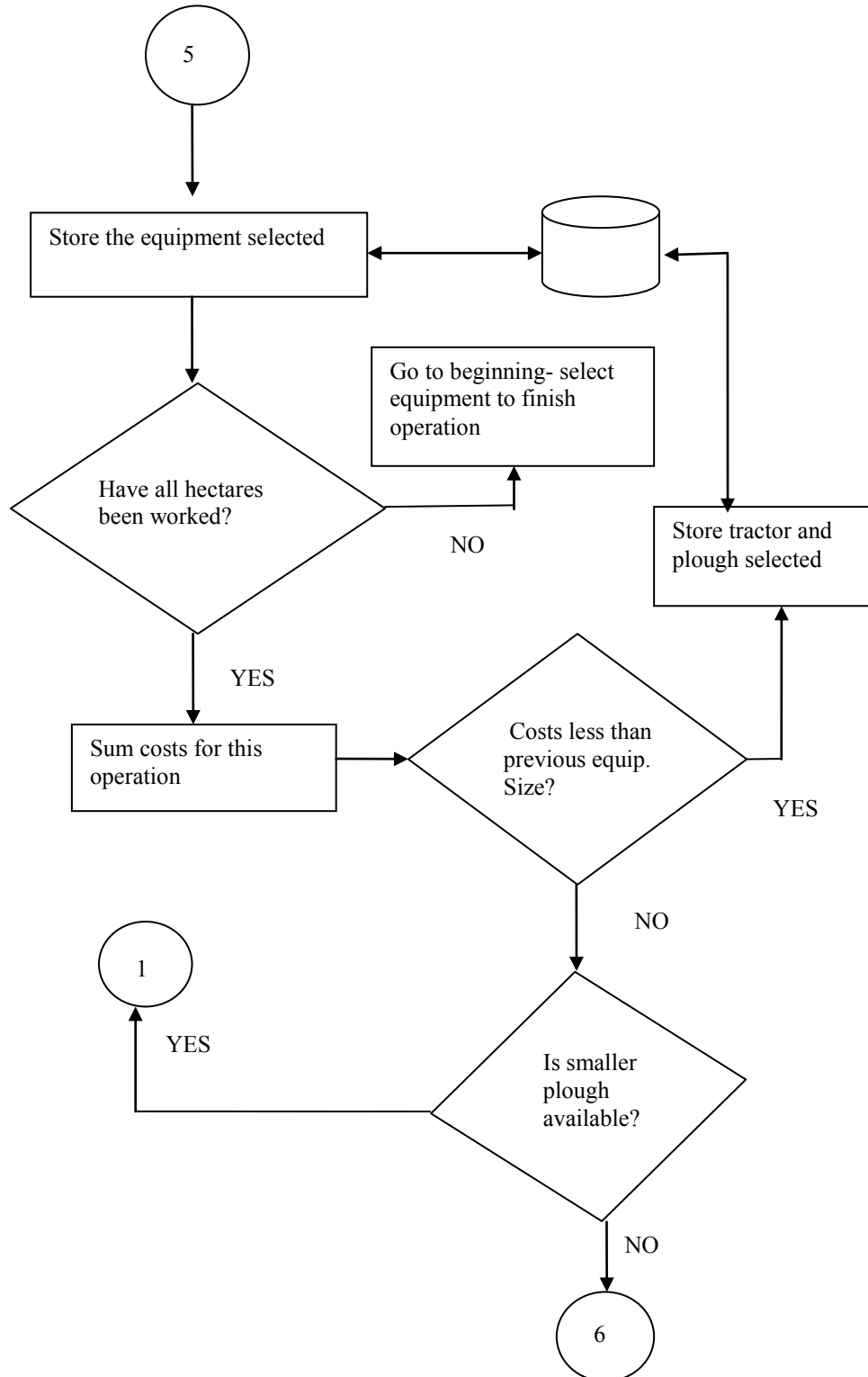

Figure 24: Flow chart C for selection of optimum tractor-plough system.

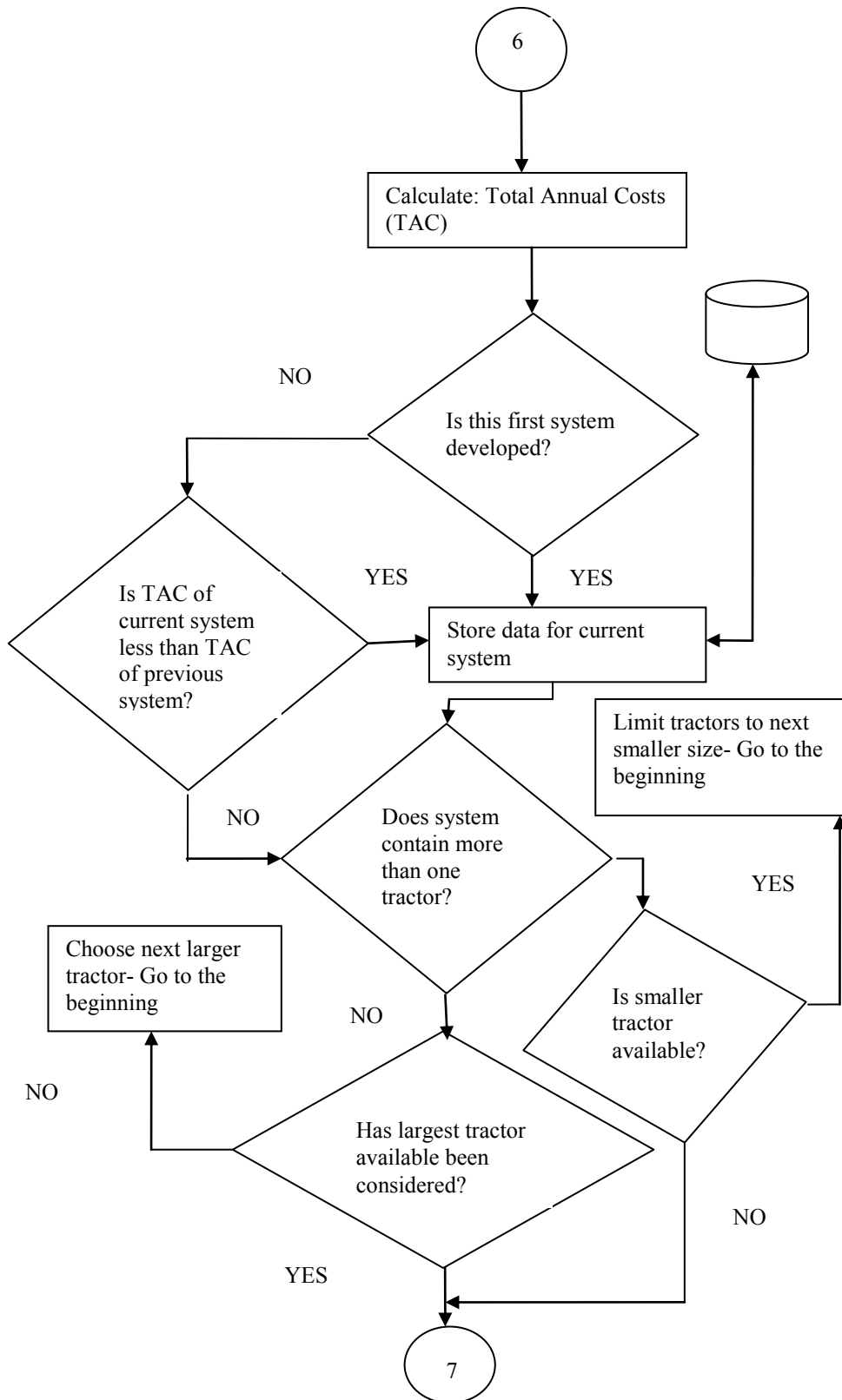

Figure 25: Flow chart D for selection of optimum tractor-plough system.

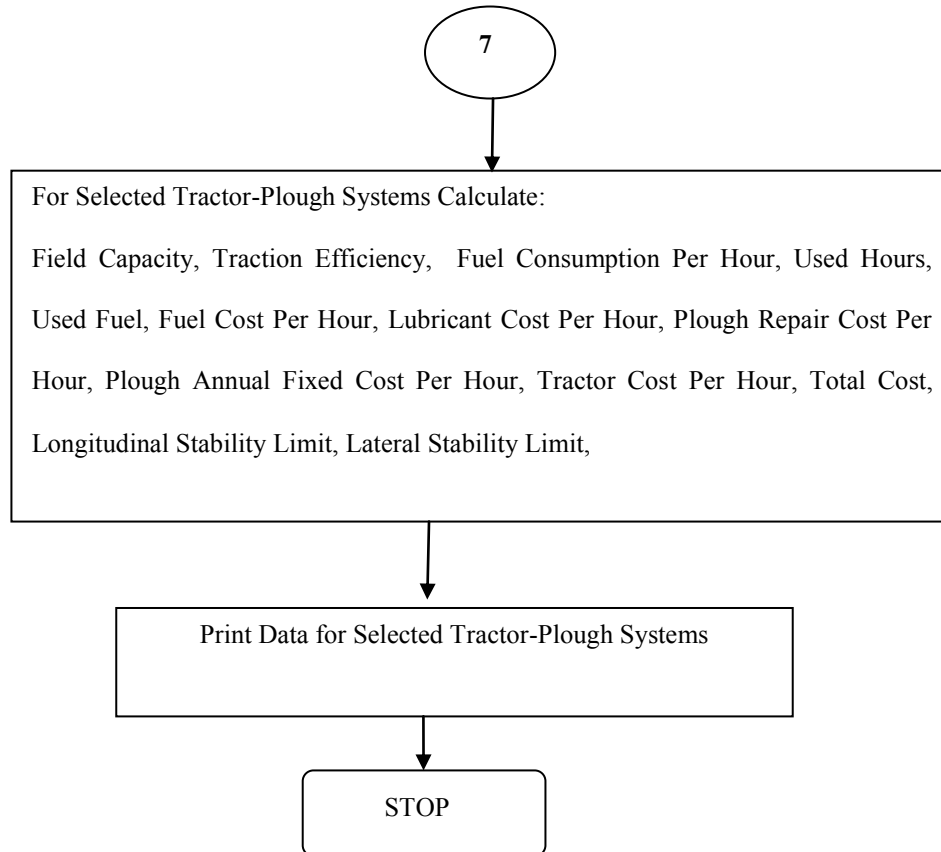

Figure 26: Flow chart E for selection of optimum tractor-plough system.

Each class contains information about an object and its methods and properties. The modules contain a set of procedures that should be executed each time they are called (Al-Hamed and Al-Janobi 2001).

From the design standpoint, the construction of the object-oriented program proceeded using the steps shown in Fig. 27. Visual Basic language provided a basic set of objects that was placed on a form while a program was being developed (Al-Hamed and Al-Janobi 2001). This was done within an integrated development environment (IDE) that made creating graphical interfaces easy.

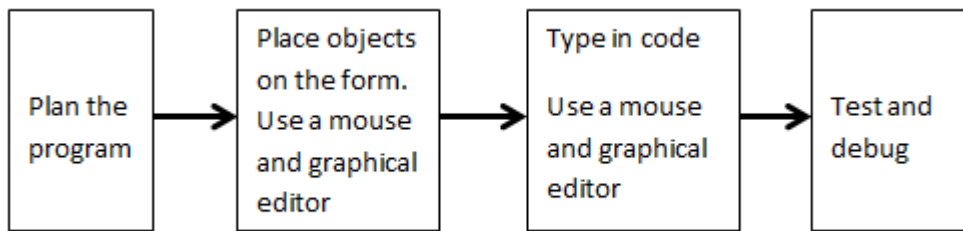

Figure 27: Steps in developing an object-based program (Bronson and Rosenthal, 2005).

Visual Basic permitted to manipulate graphical objects directly, with the programming language subsequently providing the necessary code to support the selected objects and their interface. Using Visual Basic language however, still required programmer's responsibility for: (i) Initially selecting and placing objects on a form when the program is being developed and (ii) Writing and including procedural code to correctly process events that could be triggered by the user's interaction with the programs objects when the program is run (Bol and Mohamed, 1997).

4.7.3.2 Program Modularization

The structure of the program consisted of interrelated screens and tasks arranged in a logical and easily understandable order to form an integrated and complete unit. In modular application each part of the application was designed and developed to perform clearly defined and specific function developed (Al-Hamed and Al-Janobi 2001). The segments used to construct a modular application are referred to as modules. In Visual Basic, modules that contain both the visual part of a program (the screens seen by users) and the code associated with object on the screen are called form modules.

4.7.3.3 Creating procedures and functions

The procedural code that performs actual data processing tasks is most often created in program units called general procedures which were divided into sub procedures and function procedures (Functions). Functions and sub-procedures both of which contain visual basic language instructions are essentially small procedural program units (Modules) in their own right that must be capable of receiving data operating on the data and producing a result (Bol and Mohamed, 1997). Typically, a function or sub-procedure performs a single limited task required by the larger application of which it is a part. The statements making up the procedural code conformed to prior well defined patterns or structures. These structures consist of sequence, selection, iteration and invocation.

4.7.4 Program testing

The purpose of testing is to verify that a program works correctly and fulfills its requirements. Testing requires a conscious effort to ensure that a program works correctly and produces credible and meaningful results (Bronson and Rosenthal, 2005). Program testing, thus involved running various tests including desk-checking and debugging and then running real-world data (tested with data from the study area) to make sure that the program works (Bol and Mohamed, 1997). Desk-checking simply involved reading through the program to make sure that it's free of errors and that the logic works. The program debugging involved detecting, locating and removing all syntax errors or logic errors in the computer program (Williams *et al.*, 1995).

4.7.5 Program validation

Law and McComas (2001) defined validation as the process of determining whether a simulation model is an accurate representation of the system, for the particular objective of the study. In other words, it is the degree to which a simulation model is an accurate

representation of the real world from the perspective of the intended uses of the model. Validation ensures that no significant difference exists between the model and the real system and that the model reflects reality (Vatsa and Saraswat, 2008). In the present research validation was achieved through statistical analysis.

The predicted powers of tractors were validated by comparing them with the observed power of tractors owned by farmers for specified farm sizes. The validation was done by using an appropriate statistical method. The two categories of hypothesis tests were considered: (a) Parametric tests or standard test of hypotheses, and (b) Non-parametric test or distribution free test of hypotheses. The parametric tests evaluated include: (i) Z-test (ii) t- test (iii) χ^2 – test and (iv) F- test. All these tests are based on the assumption of normality i.e., the source of data considered to be normally distribution (Kothari, 2004).

The test statistic, t is based on t-distribution and was considered as an appropriate test for judging the significance of a sample mean or for judging the significance of the difference between the means of two samples in case of small samples when population variance is not known (in which case we use variance of the sample as the estimate of as the population variance) (Kothari, 2004). The relevant test statistic, t was calculated from the sample data and then compared with its probable value based on t- distribution at a specified level of significance for concerning degrees of freedom for accepting or rejecting the null hypothesis.

CHAPTER FIVE

5.0 RESULTS AND DISCUSSIONS

5.1 Introduction

This chapter presents and discusses the results of the study on objective one, two three, four and five. The discussion starts by looking into the situation of agricultural mechanization in the study area, which is followed by a discussion on the determined soil physical properties, terrain characteristics and the related field performance parameters of tractor-plough system. The discussion continues with the analysis of theoretical and regression mathematical models developed for prediction of tractor-plough system's field performance and static overturning stability. Further, the discussion continues by looking into the Tractor-Plough System Selection Tool (TPSST) and end up with the validity of the TPSST.

5.2 The Status of Farm Mechanization in the Study Area

5.2.1 Study population characteristics

Tables 2 through 6 summarize key socioeconomic characteristics of survey respondents. Findings in Table 2 show that educational attainment of the respondents was quite low, as 5.9% of respondents had no education at all and 19.5% had universal adult education while 48.3% of the respondents had only primary school education. About twelve per cent (11.9%) of respondents had secondary school education and 14.4% of respondents had vocational education and training.

Results in Table 3 show that the majority of the respondents (67%) had 5 - 8 family members while 21.2% of the respondents listed 1 – 4 members of their households and about twelve (12%) of respondents had 9-12 family members.

Table 2: Respondents' highest level of education attained (n = 118)

Highest level of education attained	Number	Percent
Not gone to school at all	7	5.9
Universal Adult education	23	19.5
Primary School	57	48.3
Secondary School	14	11.9
Post- secondary /vocational training	17	14.4
Total	118	100

Table 3: Family size of respondents (n = 118)

Family size	Number	Percent
1-4	25	21.2
5-8	79	67.0
9-12	14	11.8
Total	118	100

Results in Table 4 show that the majority of the respondents (93.2%) were male while 6.8% of respondents were listed female. This proved the domination of male in most households.

Table 4: Gender (n = 118)

Gender	Number	Percent
Male	110	93.2
Female	8	6.8
Total	118	100

Results in Table 5 show that approximately two-third (60.2%) of respondents listed own funds as the source of finance for farming operations, followed by informal credit (35.6%) and formal credit listed low (4.2%).

Table 5: Respondents' source of finance for farming operations (n = 118)

Source of finance for farming operations	Number	Percent
Own Funds	71	60.2
Informal Credit	42	35.6
Formal Credit	5	4.2
Total	118	100

Findings in Table 6 show that farming cum provision of tractor hiring service was a group of income generating activities listed by the majority of respondents (45.8%), followed by farming activity with 26.3% of respondents. About twelve per cent of respondents listed a group with income from farming and business activities, whereas 9.3% of respondents listed two income-generating activities, which consisted of farming and employment. Eight respondents (6.8%) listed three income generating activities i.e. farming, tractor hiring services and employment. The results suggest concluding that smallholder farmers in the study area have limited access to formal credit. Largely they depend on their own source of income and informal credit to operate their farms. There was an indication that more diversified sources of income in the household were linked to higher levels of farm equipment acquisition and/or energy expenditure.

Table 6: Diversity of income generating activities (n = 118)

Diversity of income generating activities	Number	Percent
Farming only	31	26.3
Farming and Tractor Hiring service	54	45.8
Farming, Tractor Hiring Services and Employee	8	6.8
Farming and Employee	11	9.3
Farming and Business	14	11.9
Total	118	100

5.2.2 Utilization of farm tractors and equipment in the study area

Findings in Table 7 show that approximately two third of the respondents (67.8%) listed 0.4 - 2 ha of farm land ownership, while 30.5% of the respondents owned 2.5- 4 ha of farm land. The remaining respondents (1.7%) had 4.5-6 ha. The results are in agreement with the studies conducted by Shetto (2004) and URT (2006) which reported that Tanzanian agriculture is dominated by scattered smallholder farmers who cultivate 85% of the total arable land (10.1 million ha) working between 0.2 and 2.0 ha with an average per capita holding of only 0.2 ha per household.

Table 7: Total farm land owned (n = 118)

Farm land size (ha)	Number	Percent
0.4 – 2	80	67.8
2.5- 4	36	30.5
4.5- 6	2	1.7
Total	118	100

Findings in Table 8 show that more than two third of the respondents (72.9%) listed 0.4 - 2 ha of cultivated farm land, while 26.3% of the respondents cultivated 2.5 - 4 ha of farm land. About one per cent of the respondents cultivated 4.5 - 6.0 ha. These findings coincide with the findings of URT (2001) which showed that smallholder farmers in the country work between 0.2 and 2.0 ha.

Table 8: Total cultivated farm land (n=118)

Farm land size (ha)	Number	Percent
0.4 – 2	86	72.9
2.5- 4	31	26.3
4.5- 6	1	0.8
Total	118	100

Findings in Table 9 show that from inventories the majority of the tractor-owners in Mvomero (79.7%) had total power less than 75 kW (100 hp). Approximately 16% of tractor-owners had total rated power ranging between 76 kW and 150 kW (100 hp and 200 hp), while a few number of tractor-owners (2.5%) had total rated power between 151 kW and 225 kW (201 hp and 300 hp) and 1.7% of the sample had total rated power more than 225 kW. However, the output of the Tractor-Plough System Selection Tool (TPSST) indicated that for tractor-owners or farmers who owned farms ranging from 0.2 ha to 8 ha the predicted economical investment in tractor-plough systems was a 34 kW tractor mounted with 0.6 m plough.

Table 9: Total available rated power

Total rated power available kW(hp)	Number	Percent
≤ 75 (100)	94	79.7
76-150 (100-200)	19	16.1
151-225 (201-300)	3	2.5
>225 (300)	2	1.7
Total	118	100

Results in Table 10 show that 50.7% of respondents (tractor-owners) indicated that their tractors were in good condition while about 34.3% of the respondents listed tractors in fairly good condition and 10.5% of the respondents indicated that their tractors were in poor condition. The remaining 4.5% of respondents listed their tractors in scrap condition.

The findings may be associated to lack of well-trained operators and mechanics to operate, maintain and repair agricultural machinery (Shetto, 2004 and URT, 2006).

Table 10: Overall condition of tractors (n= 67*)

Overall condition of tractors	Number	Percent
Good	34	50.7
Fairly Good	23	34.3
Poor	7	10.5
Scrap	3	4.5
Total	67	100

* (Tractor-Owners)

Findings in Table 11 show that from inventories approximately thirty nine per cent (38.9%) of tractor-operated implements were disc ploughs while 32.1% of implements were harrows and trailers were 28.6% of the total number of tractor-operated implements. The other listed type of implement was riggers with 0.4% of the total implements. This implies that majority of them use mechanical energy mainly for three operations namely ploughing, harrowing and transport. Other operations were performed either manually or by using traction animals (Shetto, 2004 and URT, 2006). Most farmers had mechanization degree (MD) ranging from 0.21 to 0.40 (63.5).

Table 11: Type and number of tractor-operated implements

Type of implement	Number	Percent
Ploughs	109	38.9
Harrows	90	32.1
Riggers	1	0.4
Trailers	80	28.6
Total	280	100

Findings in Table 12 show that approximately sixty one per cent (61.2%) of the tractor-owners possessed one to four tractor-attached implements and about twenty five per cent (25.4%) of the respondents had 5 to 8 tractor-attached implements. Seven respondents (10.4%) listed 9 to 12 owned implements while two, about three per cent (3%), had more than twelve implements. This also was proved by determined mechanization degree (MD) ranging from 0.21 to 0.40 (63.5). Majority of farmers used mechanical energy mainly for three operations, namely ploughing, harrowing and transport (Shetto, 2004) and URT, 2006). Other operations were performed manually.

Table 12: Total number of owned tractor-operated implements (n = 67)

Number of implements	Number	Percent
1-4	41	61.2
5-8	17	25.4
9-12	7	10.4
Above 12	2	3.0
Total	67	100

Findings in Table 13 show that approximately sixty three per cent (62.7%) of the respondents (tractor-owners) listed field capacity less than 0.55 ha/h and about nineteen per cent (19.4%) of the respondents listed field capacities ranging from 0.56 to 0.75 ha/h, while capacities ranging from 0.76 to 0.95 ha/h were listed by 12 (17.9%) respondents. The findings showed that the field capacities reported by majority of tractor-owners (0.55 ha/h) were higher than the field capacities determined in the study area (0.48 ha/h), whereas the predicted field capacities (0.79ha/h) were much higher compared to the reported and determined in the study area. The predicted and measured field capacities were more reliable compared to field capacities subjectively reported by tractor owners.

Table 13: Average tractor field capacity (n = 67)

Field Capacity (Ha/h)	Number	Percent
0 - 0.55	42	62.7
0.56 - 0.75	13	19.4
Above 0.75	12	17.9
Total	67	100

Results in Table 14 show that dealers' credit and mechanization program scored 31.3% and 46.3% respectively. About twenty two per cent (22.4%) of respondents stated that they acquired tractors and implements using their own funds. The findings suggest concluding that the agricultural credit program sponsored by the government supplied tractors to small farmer to improve production (46.3%). The contribution of farm machinery dealers in promoting farm mechanization through provision of credit to farmers was also significant (31%). Agricultural credit is recognised as an important factor in stimulating agricultural production. The government is required to ensure that a formal agricultural credit program is enhanced and sustained. The economics of rural communities have played a prime role in the mechanization of farmers in the study area.

Table 14: Mechanism for farm machinery acquisition (n= 67)

Mechanism for machinery acquisition	Frequency	Percent
Own funds	15	22.4
Dealer Credit	21	31.3
Mechanization program	31	46.3
Total	67	100

Findings in Table 15 show that Fiat and Ford tractors were stated as the most preferred makes of tractors with 41.8% and 37.3% respectively. Massey Ferguson and New Holland

are the least preferred makes of tractors with 19.4% and 1.5 % respectively. Prior experience with Fiat and Ford tractors was the reason behind these preferences. The Fiat and Ford makes were very common in Mvomero District (Appendices 10 – 14).

Table 15: The most preferred make of tractor (n = 67)

Most preferred make of tractor	Number	Percent
Fiat	28	41.8
Ford	25	37.3
MF	13	19.4
N. Holland	1	1.5
Total	67	100

Results in Table 16 show that small size tractors (less than 60 kW) and medium size tractors (from 60- 112 kW) were the most stated sizes with 34.3% and 43.3% of the respondents respectively, while large tractors (>112 kW) were stated that they were mostly suitable by 22.4% of the respondents.

Considering the sizes of farms owned by tractor- owners, the preferred sizes of tractors were big compared to the sizes of farms owned by farmers. If these preferences were implemented then it could lead to uneconomical investment. The Tractor–Plough System Selection Tool (TPSST) selected a 34 kW tractor matched with a 0.6m plough as the lest-cost option to cultivate a farm of 8 ha.

Table 16: The most preferred size (power) of tractor (n = 67)

The most preferred size of tractor	Number	Percent
Small < 60 kW(80 hp)	23	34.3
Medium 60 - 112 kW (80 - 150 hp)	29	43.3
Large >112 kW (150 hp)	15	22.4
Total	67	100

Findings in Table 17 show that price, availability of spare parts and durability were the most commonly stated criteria in choosing a tractor with 12.7%, 15.3%, and 12.7% respectively followed by fuel consumption (9.3%), power efficiency (5.1%) and prior experience with the tractor (1.7%).

Table 17: Criterion that is given first priority in choosing a tractor (n= 67)

Criterion given first priority	Frequency	Percent
Low Price	15	12.7
Availability of Spare Parts	18	15.3
Low Fuel Consumption	11	9.3
Durability	15	12.7
Power Efficiency	6	5.1
Prior experience	2	1.7
Total	67	100

Findings in Table 18 show that the practice of selective mechanization was prominent for all the respondents. Mechanical operations were limited only to tillage operations such as ploughing, and harrowing. Other operations like planting, weeding, fertilizer application and harvesting are mainly manually done. Findings show that majority of the respondents had mechanization degree (MD) ranging from 0.21 to 0.40 (63.5) followed by those who had MD in the range of 0.41 to 0.60 (22.9). About twelve per cent of the respondents had MD in the range of 0.0 to 0.20 and only 1.7% of the respondents had MD above 0.60. This

implies that the ratio of mechanized area to the total required one were comparatively low. This data indicated that out of all operations required for production of maize only two to four operations were mechanized. They included ploughing, harrowing and transportation. The findings suggest concluding that the achievement in mechanization in the study area was comparatively low.

Table 18: Mechanization degree (n=118)

MD [decimal]	Number	Percent
0.0 - 0.20	14	11.9
0.21- 0.40	75	63.5
0.41- 0.60	27	22.9
Above 0.60	2	1.7
Total	118	100

Table 19 shows results of computed mechanization index for respondents from the study area based on the premise that a mechanized farmer is the one that finds a way to utilize amounts of mechanical energy that are higher than the typical values using locally available technologies.

Findings show that majority of the respondents had mechanization index (MI) ranging from 0.00 to 0.01 (66.1%) followed by those who had MI in the range of 0.011 to 0.02 (19.5%). The findings further show that 9.3% of the respondents had MI in the range of 0.021 to 0.03 and only 5.1% of the respondents had MI above 0.03. This indicated that utilization of mechanical energy in the study area was very low.

Table 19: Mechanization index (n=118)

M I[decimal]	Number	Percent
0.00 - 0.01	78	66.1
0.011- 0.02	23	19.5
0.021- 0.03	11	9.3
Above 0.03	6	5.1
Total	118	100

In studying the mechanization capacity in producing crop products in the study area using three energy resources (human, animal and mechanical) the total consumed energy through these three sources of power was determined and are shown in Table 20. Findings show that 68.7 % of the total energy used was tractor energy followed by human energy with 30.3% and the draught animal energy was only 1%.

UNIDO (2013) has defined 12 different levels of Agricultural Mechanization: the highest levels of mechanization (levels 9–12) can typically be found in the USA and Western European countries. By contrast, exceptionally low levels of mechanization persist in many developing countries, particularly in Africa, which remains the most challenging region for mechanization. Here, average mechanization levels range from 5 (Morocco), 4 (Botswana) to merely 1 in Cameroon (UNIDO, 2013). Mechanization level 1 means 5 tractors for every 1000 ha, whereas mechanization level 4 means 20-49 tractors per 1 000 ha. In Mvomero District findings indicated 0.35 tractors for every 1 000 ha. At national level finding showed that there are about 2 tractors per 1 000 ha.

Table 20: Estimate of energy used from each source

Type of energy resource	Amount consumed (kW- h/ha)	Percent
Human energy	13.82	30.3
Animal Energy	0.44	1.0
Tractor Energy	31.34	68.7
Total	45.6	100

The study also determined the number of all active tractors in the district which are used as the source of draught power to establish the level of mechanization. Having the total power of all tractors in the district and the arable area of the district being 549 375 hectares, the mechanization level computed using equations (39) and (40) from sub section 4.6.2.2 was 0.015 kW/ha and this was equal to the mechanization level of the country which was estimated to be 0.015 kW per hectare.

However, this value is twice higher than the estimated regional level of mechanization which was 0.008 kW/ha. The study further revealed that underutilization of mechanical power, and uses of old tractors with constant break down during operation were among the factors which contributed to low level of mechanization in the study area.

Regarding the responses of service providers, extension workers and tractor operators, there was a consensus about the status of farm mechanization achieved in the study area. Responses ranged from poor to fair-mechanization. There was also an absolute agreement that there should be a priority on the increase of the mechanization level. Low volume of business resulting to poor cash flow due to the seasonality of demand of agricultural machinery and implements was one of the major constraints raised by service providers. Farm size stood as the factor with the most weight in the introduction of mechanization.

The major constraints listed by extension workers were: low purchasing power of most small scale farmers, low producer prices, high cost of agricultural machinery, and lack of agricultural credit. Other constraints included: lack of well-trained operators and mechanics to operate, maintain and repair agricultural machinery, lack of suitable machinery packages for main agricultural operations, importation of tools, equipment and machinery of poor quality, and general poor technical knowhow. These results are in agreement with the study results obtained by Shetto (2004) and URT (2006).

Most common reported problems by tractor operators, related to bearing, pistons, rings, sleeves, and hydraulic systems. The operators argued that frequent breakdowns are common as many tractors in operation are of old age, beyond their economic life of 10 years (Appendices 34-38). The situation is exacerbated by high prices of spare parts, poorly trained operators and mechanics and lack of well-equipped workshops to carry out repair services. This was also concluded by URT (2006). The most important aspects to look for when acquiring farm equipment listed by the extension workers and tractor-owners were those of financial nature (price and credit availability/terms), followed by technical aspects (work capacity, durability, ease of operation) and service/maintenance aspects being the least considered.

5.3 Soil and Terrain Characteristics in the Study Area

The data on soil and terrain conditions collected from the study area including soil texture, moisture content, bulk density, cone index and slope gradient is presented in Table 21. The findings of the soil test in Table 21 indicated that there was a minimal variation of soil physical properties. The dominant soil texture is sandy clay except in few sites, i.e. Mvomero II (sand 57%, clay 33% and silt 10%) and Mkindo village (clay 38%, sand 60%, and silt 2%).

The findings show that the moisture content varied significantly from d.b. 3.66 % in Mvomero II to 13% d.b. in Hembeti. The findings also showed that the variation of bulk density was minimal as the lowest was 1.08 [kg/m³] whereas the highest was 1.47 [kg/m³]. Measurement of soil resistance to penetration (Soil cone index) indicated that the highest cone index was in Wami Luhindo village (2 887 kPa) whereas the lowest cone index was in Mvomero village site II (856 kPa). Further, the findings showed that the steepest slope gradient of test sites was in Mvomero I (16%) followed by Mvomero II (10%) and Hembeti (7%). The remaining sites were almost flat (0 – 5%).

Table 21: Soil and terrain physical properties

Village (Site)	Soil Texture (%)			MC d.b. (%)	BD (kg m-3)	CI (kPa)	Grad. (%)
	Sand	Clay	Silt				
Wami Lukindo	51	46	3	8.78	1.38	2887	1**
Dakawa Mnadani	45	53	2	5.98	1.38	2203	1**
Milama	51	48	1	6.07	1.47	1875	1**
Mvomero I	53	46	1	3.99	1.24	1658	16*
Mvomero II	57	33	10	3.66	1.39	856	10**
Mvomero III	53	46	1	3.86	1.31	1897	3**
Mkindo	60	38	2	9.93	1.13	1732	1**
Hembeti	49	49	2	13.54	1.08	1688	7**

* = Sideways slope, ** = Rearwards slope

MC = Moisture Content, BD = Bulky Density, CI = Cone Index, Grad. = Gradient

Statistical analysis was carried out on the collected data in Table 21 and the results are presented in Table 22. Generally the findings of the soil test in Table 22 indicated that the minimum and maximum amount of clay soil in the study area was 33% and 53% respectively while the mean value was about 45%. For silt soil the findings showed that the minimum and maximum content were 1% and 10% respectively. The findings also showed that the minimum content of sand soil was 45% while the maximum content of sand soil was 60%. Further, the findings in Table 22 showed that the minimum value of

Cone Index, moisture content and bulk density was 0.86 MPa, 3.66% and 1.08 kg/m³ respectively while the maximum amount of each was 2.89 MPa, 13.54% and 1.47 kg/m³ respectively. The mean value of cone index was 1.85 MPa and the mean value of moisture content and bulk density was 6.98% and 1.30 kg/m³ respectively.

Table 22: Statistics of soil physical properties

Soil Physical Property	N	Minimum	Maximum	Mean	Std. Dev.
Clay Soil (%)	8	33.00	53.00	44.88	6.38
Silt Soil (%)	8	1.00	10.00	2.75	3.01
Sand Soil (%)	8	45.00	60.00	52.38	4.63
Moisture Content d.b. (%)	8	3.66	13.54	6.98	3.52
Bulk Density (kg/m ³)	8	1.08	1.47	1.30	0.14
Cone Index (MPa)	8	0.86	2.89	1.85	0.57

5.4 Tractor-Plough System's Field Performance Parameters in the Study Area

Table 23 shows the results of tractor-plough system performance tests conducted in eight sites in selected villages of Mvomero District. The field performance parameters involved in the tests were: width of cut, depth of cut, wheel slip, actual ploughing speed, implement draught force and power, drawbar pull required to pull the plough, fuel consumption, theoretical and actual field capacities, and field efficiency.

Table 24 shows the descriptive statistics of the results of tractor-plough system performance tests. The findings show that the minimum and maximum widths of cut were 0.8 m and 1.10 m respectively. The findings also show that the mean and standard deviation of measurement results were 0.91m and 0.09 m respectively. The minimum and maximum depths of cut were 12 cm and 26 cm respectively whereas the mean and standard deviation were 19 cm and 5 cm respectively.

Table 23: Tractor-plough system's field performance parameters

Site	Field Performance Parameters*										
	WC	DC	Si	AS	D	DP	DB	Fc	CPT	CPa	Fe
Wami Lukindo	0.93	12	2.84	8.0	4.93	16.69	16.69	9.47	0.74	0.59	79
Dakawa Mnadani	0.87	14	4.20	7.7	5.38	18.07	18.07	10.98	0.66	0.56	84
Milama	1.10	13	4.97	7.4	5.10	17.60	17.60	9.17	0.82	0.62	77
Mvomero I	0.96	22	6.92	5.5	5.47	14.52	14.52	13.26	0.52	0.25	48
Mvomero II	0.87	21	3.79	7.8	5.92	18.36	18.36	12.13	0.69	0.47	70
Mvomero III	0.85	23	5.43	7.6	5.25	18.39	18.39	9.39	0.65	0.49	77
Mkindo	0.87	26	4.89	7.6	7.92	23.94	23.94	16.01	0.66	0.46	70
Hembeti	0.82	23	3.35	7.4	5.88	17.37	17.37	13.04	0.60	0.41	68

* WC = width of cut (m), DC = depth of cut (cm), Si = wheel slip (%), AS = actual speed (km/h), D = draught force (kN), DP = draught power (kW), DB = drawbar pull (kN), Fc = fuel consumption (Litres/ha), CPT = theoretical field capacity (ha/h), CPa = actual field capacity (ha/h), Fe = field efficiency (%)

Minimum and maximum wheel slips were 2.84% and 6.92% respectively, and the mean and standard deviation were 4.55% and 1.30% respectively. The findings also show the following results: minimum and maximum draught forces were 4.93 kN and 7.92 kN while the mean and standard deviation were 5.73 kN and 0.95 kN respectively. Minimum and maximum draught powers were 14.52 kW and 23.94 kW while the mean and standard deviation were 18.12 kW and 2.67 kW respectively.

Regarding the fuel consumption, the results show that the minimum and maximum values were 9.12 l/ha and 14.01 l/ha respectively, whereas the mean and standard deviation were 10.44 l/ha and 1.80 l/ha respectively. Results of field test of rolling resistance in the Table 24 show that the minimum and maximum values were 2.5 kN and 3.5 kN while the mean and standard deviation were 3.13 kN and 0.44 kN respectively. Findings of theoretical field capacity in Table 24 show that the minimum and maximum values were 0.52 ha/h and 0.82 ha/h respectively. The mean and standard deviation from the mean theoretical capacity were 0.67 ha/h and 0.09 ha/h respectively.

Table 24: Descriptive statistics of tractor-plough system's field performance parameters

Field Performance Parameter	N	Minimum	Maximum	Mean	Std. Dev.
Width of Cut (m)	8	0.82	1.10	0.91	0.09
Depth of cut (cm)	8	12	26	19	5.0
Wheel Slip (%)	8	2.84	6.92	4.55	1.30
Draught Force (kN)	8	4.93	7.92	5.73	0.95
Draught Power (kW)	8	14.52	23.94	18.12	2.67
Fuel Consumption (l/ha)	8	9.12	14.01	10.44	1.80
Rolling resistance (kN)	8	2.50	3.50	3.13	0.44
Theoretical field capacity (ha/h)	8	0.52	0.82	0.67	0.09
Actual field capacity (ha/h)	8	0.25	0.62	0.48	0.12
Field Efficiency (%)	8	48	84	71	11.0
Actual Ploughing Speed (km/h)	8	5.50	8.00	7.38	0.78

Determination of actual field capacity of the tractor-plough system resulted with the following findings: minimum, maximum, mean and standard deviation values in ha/h were 0.25, 0.62, 0.48 and 0.12 respectively. Findings in Table 24 also show that the minimum, maximum, mean and standard deviation values of field efficiency were 48%, 83%, 71%, and 11% respectively. Finally the results of actual ploughing speed in km/h show that the minimum, maximum, mean and standard deviation were 5.50, 8.00, 7.38 and 0.78 respectively.

5.5 Multiple Regression Models for Predicting Tractor-Plough System's Field Performance Parameters in the Study Area

5.5.1 Introduction

Multiple-linear regression analysis was employed for assessing the strength of the relationship between each of a set of independent variables and a single dependent variable. For each model, the following statistics were of concern: regression coefficients,

multiple R , R^2 , adjusted R^2 , standard error of the estimate. Other statistics considered are: 99%, 95% and 90%-confidence intervals for each regression coefficient, variance inflation factor, tolerance. Co-linearity diagnostics were tested in order to detect whether there is correlation among the independent (X_n) variables.

5.5.2 Regression models for predicting draught power

Using SPSS software Version 11.5 (2002), regression models were run to quantify the effect of the factors (independent variables) contributing to the draught power. The independent variables included soil moisture content, cone index, width of cut, depth of cut, draught force, rolling resistance and working speed. The following regression model was formulated to estimate the draught power:

$$Y_{dp} = -22.710 - 0.265X_1 + 0.090X_2 + 0.154X_3 - 0.069X_4 + 0.913X_5 + 0.328X_6 + 0.678X_7 \quad (27)$$

Findings in Table 25 show that except for independent variable of depth of cut, the Variable Inflation Factor VIF values were less than five which implies that no linear relationship exists between and among two or more of the independent variables. Table 25 presents predictors influencing the draft power whereby regression was significant ($p \leq 0.01$) and the seven independent variables account for 100% (Adjusted $R^2 = 0.96$) of draft power. Further findings show that all seven independent variables included in the analysis have significant ($p \leq 0.01$) regression coefficients.

Draught force was the highest predictor of draft power (standardized regression coefficient of 0.913, significant at $p \leq 0.01$). The positive regression coefficient implies that draft force and draft power are positively related. Increase in draft force leads to increase in

draft power. A change of draft force by 1 unit translates into a change of draught power by a factor of 0.913.

Working speed had a standardized regression coefficient of 0.678, significant at ($p \leq 0.01$). The positive regression coefficient implies that working speed and draft power are positively related. Increase in working speed increases draft power. This is because at higher speeds the draught force will generally increase due to the fact that higher speeds involve greater acceleration of the soil and that soils are slightly stronger under dynamic conditions. Hence implements such as disc ploughs that lift and move soil a greater distance and have large draught due to friction and adhesion show a greater increase in draught with speed (Macmillan 2002).

Soil moisture content had a standardized regression coefficient of - 0.265, significant at ($p \leq 0.01$). The negative regression coefficient implies that moisture content and draft power are negatively related. Increase in moisture content leads to decrease in draft power. Soil cone index had a standardized regression coefficient of 0.090, significant at ($p \leq 0.01$). The positive regression coefficient implies soil cone index and draft power are positively related. Increase in soil cone index leads to increase in draft power.

Width of cut had standardized regression coefficients of 0.154, significant at ($p \leq 0.01$). The positive regression coefficient implies that width of cut and draught power are positively related. Increase in width of cut leads to increase in draught power.

Table 25: Predictors influencing the draft power

Independent Variable	Un standardized Coefficients		Standardized Coefficients	t	Sig.	Co linearity Statistics	
	B	Std. Error	Beta			Toleranc e	VIF
Constant	-22.710	0.000		.	.		
Moisture Content [%]	-0.201	0.000	-0.265	.	.	0.587	1.704
Cone index [kPa]	0.420	0.000	0.090	.	.	0.348	2.876
Width of cut [m]	4.622	0.000	0.154	.	.	0.352	2.839
Depth of cut [m]	-3.433	0.000	-0.069	.	.	0.090	11.145
Draught force [kN]	2.566	0.000	0.913	.	.	0.335	2.983
Rolling resistance [kN]	1.976	0.000	0.328	.	.	0.262	3.816
Working speed [km/h]	2.310	0.000	0.678	.	.	0.443	2.255

Dependent variable: Draught power [kW], R square (R^2) = 0.98, Adjusted R Square (R^2) = 0.96

F-statistics (for R^2) = 0.94*, * = significant at .01 level

Depth of cut had standardized regression coefficients of - 0.069, significant at ($p \leq 0.01$). The negative regression coefficient implies that depth of cut and draft powers are negatively related. This is unexpected relationship because an increase in depth of cut would lead to an increase of draft power as a result of increased load (soil resistance). Variation in soil texture and bulk density could be the possible cause of this shortfall. Large depth of cut in less compacted soil required small draught force, whereas small depth of cut in highly compacted clay soil required big draught force. This shortfall calls for more studies to address the phenomenon. Rolling resistance had standardized regression coefficients of 0.328, significant at ($p \leq 0.01$). The positive regression coefficient implies that rolling resistance and draft power are positively related. Increase in draft power leads to increase in rolling resistance.

5.5.3 Multiple linear regression models for predicting fuel consumption

Using SPSS software Version 11.5 (2002), regression models were run to quantify the effect of independent variables to the fuel consumption. The independent variables included: moisture content, variables contributing cone index, and width of cut, depth of cut, draught force, rolling resistance and working speed. The following regression model was formulated to estimate the fuel consumption:

$$Y_{fc} = 8.029 - 0.404X_1 - 0.075X_2 - 0.287X_3 - 0.535X_4 + 1.282X_5 - 0.138X_6 + 0.049X_7 \quad (28)$$

From the results in Table 26 it was observed that except for independent variable of depth of cut, the Variable Inflation Factor (VIF) values were less than five which implies that no linear relationship exists between and among two or more of the independent variables.

Table 26: Predictors influencing the fuel consumption

Independent Variables	Un standardized Coefficients		Standardized Coefficients			Co linearity Statistics	
	B	Std. Error	Beta	t	Sig.	Tolerance	VIF
Constant	8.029	0.000					
Moisture Content	-0.207	0.000	-0.404	.	.	0.587	1.704
Cone Index	-0.236	0.000	-0.075	.	.	0.348	2.876
Width of cut	-5.797	0.000	-0.287	.	.	0.352	2.839
Depth of cut	-17.875	0.000	-0.535	.	.	0.090	11.145
Draught force	2.430	0.000	1.282	.	.	0.335	2.983
Rolling resistance	-0.561	0.000	-0.138	.	.	0.262	3.816
Working speed	0.112	0.000	0.049	.	.	0.443	2.255

Dependent Variable: Fuel Consumption in litres per ha [L/ha], R square (R^2) = 0.94

Adjusted R Square (R^2) = 0.92, F-statistics (for R^2) = 0.90*, * = significant at 0.01 level

Draught force was the highest predictor of fuel consumption (standardized regression coefficient of 1.282, significant at $p \leq 0.01$). The positive regression coefficient implies that draught force and fuel consumption are positively related. Increase in draft force leads

to increase in fuel consumption. A change of draft force by 1 unit translates into a change of fuel consumption by a factor of 1.282. Working speed had a standardized regression coefficient of 0.049, significant at ($p \leq 0.01$). The positive regression coefficient implies that working speed and fuel consumption are positively related. Increase in working speed increases fuel consumption.

Soil moisture content had a standardized regression coefficient of - 0.404, significant at ($p \leq 0.01$). The negative regression coefficient implies that moisture content and fuel consumption are negatively related. Increase in moisture content decreases fuel consumption due to the fact that moist soils shear easily hence decreasing implement draught force hence lower fuel consumption. Soil cone index had a standardized regression coefficient of - 0.075, significant at ($p \leq 0.01$). The negative regression coefficient implies that soil cone index and fuel consumption are negatively related. The relationship between soil cone index and fuel consumption unexpectedly showed that an increase in soil cone index leads to a decrease in fuel consumption. However, theoretically it was expected that, an increase in soil cone index would lead to an increase in fuel consumption due to increased soil resistance (increased load). The possible cause of this phenomenon may be implicated to variation in soil texture and shallow depth of cut (reduced load) due to hard pan which was common in the study area. However, this anomaly indicates that there is a need of further work to address the shortfall.

Findings in Table 26 show that width of cut, depth of cut and rolling resistance had standardized regression coefficients of - 0.287, - 0.535 and -0.138 respectively. The relationship between width of cut, depth of cut and rolling resistance and fuel consumption unexpectedly showed that an increase in width of cut, depth of cut and rolling resistance leads to a decrease in fuel consumption. Theoretically it was expected

that, increase in width of cut, depth of cut and rolling resistance would lead to increase in fuel consumption.

There are three possible causes of these shortfalls. Firstly, the irrational variation in soil texture may be the reason behind these irrational results. Secondly, possibly the required tractor settings in terms of gear ratios and engine speed during experiments were not kept constant. Randomly changing engine speed from 2000 rpm to 2200 rpm and vice versa during experiment possibly could be the cause of irrational fuel consumption with respect to the changes of engine loads. The required setting of tractor engine speed for fuel consumption measurement was 2000 rpm at a gear ratio position H1 (High 1). Thirdly, the tractor engine was not tuned up and tested before experiments. Existence of unnoticed malfunction in the tractor fuel injection system probably could be the cause. In such a situation small changes in width of cut, depth of cut or rolling resistance could not cause proportional change in the fuel consumption. In other words possibly the engine was insensitive to small changes of loads caused by small changes in depth of cut, width of cut or rolling resistance. However, the above stated anomalies also imply that there is a need to conduct further studies to identify the real causes of the shortfalls.

5.6 Static Overturning Stability Limits of Tractor–Plough Systems

5.6.1 Introduction

The translation of theoretical mathematical models, developed in Section 4.2 and 4.3, into Visual Basic (VB 6) programme was carried out in accordance with the flow chart presented in Fig. 17. Slope angle was varied in several equal steps. The technical specifications and design parameters used for stability analysis were obtained from Massey Ferguson Tractor model MF491.

5.6.2 Effects of design parameters on rearwards static overturning stability limits

Simulation results in the second column of Table 27 show that as the weight (W_p) of mounted plough decreases, the maximum slope angle at which the system can operate (slope capability) increases. In the third column the simulation results show that as the height of centre of gravity of the mounted plough (h_p) decreases the more the system is stable i.e. the tractor's slope capability (TSC) increases.

Table 27: Simulated effects of design parameters on rearwards static overturning stability limits

Maximum Slope Angle(deg)	Tractor- plough system design parameters					
	W_p (kN)	h_p (m)	h_t (m)	X_r (m)	X (m)	X_g (m)
1	2	3	4	5	6	7
2	29.7	175.8	21.2	0.1	0.4	7.1
4	27.5	83.1	10.6	0.2	0.6	6.9
6	25.5	52.1	7.0	0.2	0.6	6.6
8	23.6	36.6	5.3	0.2	0.8	6.3
10	21.7	27.3	4.2	0.3	0.9	6.1
12	20.0	21.0	3.5	0.3	1.0	5.8
14	18.3	16.5	3.0	0.3	1.1	5.5
16	16.7	13.1	2.6	0.4	1.2	5.3
18	15.2	10.5	2.3	0.4	1.3	5.0
20	13.7	8.4	2.0	0.4	1.4	4.7
22	12.3	6.6	1.8	0.5	1.6	4.4
24	10.9	5.1	1.7	0.5	1.7	4.1
26	9.5	3.8	1.5	0.6	1.8	3.8
28	8.2	2.7	1.4	0.6	2.0	3.4
30	6.9	1.8	1.3	0.6	2.1	3.1
32	5.7	2.7	0.9	1.2	0.7	2.3
34	4.4	2.4	0.2	1.1	0.7	2.4
36	3.2	2.0	-0.5	1.0	0.8	2.6
38	2.0	1.6	-1.1	1.0	0.8	2.7
40	0.8	1.2	-1.7	0.9	0.9	2.9
42	-0.4	0.7	-2.2	0.8	0.9	3.1
44	-1.6	0.2	-2.7	0.8	1.0	3.3

Source: simulation results

The simulation results in the fourth column also show that the decrease of the height of centre of gravity of the tractor (h_t) from the ground increases the stability of the system. The influences of the horizontal dimension of the centre of gravity (X_r) from the rear axle and the wheel base (X) of the tractor are presented in the fifth and sixth columns of Table

27 respectively. Findings show that, as the values of both parameters were increased the more the system became stable, that is the TSC increased. The horizontal dimension from the rear axle to the centre of gravity (X_g) of mounted plough has also an effect on the maximum slope angle. This is presented in column seven of Table 27. The results show that, as the dimension increases the maximum slope angle at which the system operates stability decreases.

5.6.3 Effects of design parameters on sideways static overturning stability limits

In this case only two design parameters were found to be relevant to sideways static overturning stability. These include the average wheel track (Z_t) and the height of centre of gravity of tractor from the ground (h_t). Simulation results of the effect of these two design parameters on the sideways stability of the tractor-plough system operating across a slope are presented in Table 28. The results show that both design parameters significantly affect the stability of the tractor-plough system. This is in agreement with Demsar *et al.* (2012) who showed that manipulating these parameters can significantly increase tractor plough system's static stability.

A better static stability is directly proportional to improved dynamic stability, resulting in a better safety in a view of the tractor overturn, particularly while working on a sloping terrain. The findings show that the increase of wheel track of tractor increases the maximum slope angle at which the tractor can move steadily across the slope with lifted plough (in transport position) without overturning sideways. The height of the centre of gravity of the tractor from the ground also has a big effect on the sideways stability. The results show that the decrease of the height of the centre of gravity (h_t) increases the stability of the system i.e. increases the capability of the system to operate at comparatively steeper slope angle.

Table 28: Effects of design parameters on sideways static overturning stability limits

Slope Angle (deg)	Wheel Track (Zt) (m)	Height of CG (ht) (m)
2	0.1	34.4
4	0.1	17.1
6	0.2	11.4
8	0.2	8.5
10	0.3	6.7
12	0.4	5.6
14	0.4	4.7
16	0.5	4.1
18	0.6	3.6
20	0.6	3.2
22	0.7	2.9
24	0.8	2.6
26	0.8	2.4
28	0.9	2.2
30	1.0	2.0
32	1.1	1.8
34	1.2	1.7
36	1.2	1.6
38	1.3	1.4
40	1.4	1.3
42	1.5	1.2
44	1.7	1.1

Source: Simulation Results

5.6.4 Rearwards and sideways static overturning stability limits for sampled tractor-plough systems

In this study rearwards and sideways static overturning stability indices (limits) for twenty tractors were predicted and tested for their slope capability on three sites in Mvomero I Mvomero II and Hambeti with slope angles of 16°, 10°, and 7° respectively. Findings in Tables 29 show that rearwards static overturning stability limits were much lower compared to the sideways static overturning stability limits.

Table 29: Rearwards and sideways static overturning stability limits for sampled tractor-plough systems

Tractor ID	Wt (kN)	Xr (m)	ht (m)	X (m)	Xg (m)	hp (m)	Zt (m)	Wp (kN)	RSOSI* (ratio)	SSOSI** (ratio)
1	2	3	4	5	6	7	8	9	10	11
1	25.31	0.6	0.53	2.0	2.64	1.76	1.69	3.1	0.3738	1.2790
2	28.06	0.71	0.76	2.35	2.76	1.82	2.18	4.0	0.3069	1.2235
3	28.01	0.69	0.76	2.29	2.76	1.82	2.14	4.7	0.2113	1.1767
4	34.52	0.69	0.76	2.29	3.01	1.63	2.18	5.4	0.2131	1.2430
5	41.93	0.78	0.96	2.29	3.07	1.51	2.15	3.6	0.4774	1.0705
6	42.06	0.78	0.95	2.29	3.07	1.51	2.14	7.0	0.2264	1.0361
7	128.92	1.17	0.87	3.91	2.89	1.85	4.77	8.0	1.0125	2.5783
8	110.16	0.99	0.76	3.28	2.89	2.10	2.76	9.0	0.8061	1.6037
9	124.12	0.99	0.76	3.28	2.89	2.10	2.76	10.0	0.8116	1.6061
10	136.6	0.99	0.76	3.28	2.89	2.10	2.76	1.6	1.2155	1.7815
11	150.82	0.99	0.76	3.28	2.75	2.10	2.76	1.8	1.2161	1.7808
12	36.35	0.66	0.85	2.19	2.74	2.07	1.78	4.7	0.2736	0.8996
13	36.65	0.66	0.85	2.19	2.86	2.07	1.95	5.2	0.2190	0.9717
14	69.76	0.9	0.89	3.0	2.92	1.85	2.03	5.8	0.6286	1.0512
15	28.53	0.62	0.68	2.05	2.88	1.61	1.88	6.0	0.0088	1.1253
16	22.18	0.61	0.62	2.04	2.72	1.65	1.93	3.4	0.2251	1.2824
17	21.16	0.59	0.74	1.95	2.95	1.91	1.86	4.3	-0.0135	0.9917
18	38.67	0.65	0.7	2.18	2.95	1.69	1.89	5.24	0.2719	1.1515
19	22.34	0.61	0.68	2.04	2.88	1.65	1.93	4.1	0.0850	1.1709
20	21.3	0.59	0.74	1.95	2.72	1.91	1.86	4.8	-0.0231	0.9736

RSOSI * - Rearwards Static Overturning Stability Index

SSOSI** - Sideways Static Overturning Stability Index

W_t = tractor weight, W_p = plough weight, X = wheel base, X_r = horizontal distance from rear axle to centre of gravity of tractor, h_t = height of centre of gravity of tractor above the ground, X_g = horizontal distance from rear axle to centre of gravity of plough, h_p = height of centre of gravity of plough above the ground, Z_t = wheel track.

This means that the tractor - plough system lost its rearwards stability (tipped) at a smaller slope gradient when operated uphill compared to its motion across the slope.

Findings in Table 30 show that out of twenty tractor-plough systems tested only eight systems (45%) passed or were safer to operate on the Mvomero I site with slope angle of 16° . Findings further show that sixteen tractor-plough systems (80%) were capable to operate safely on farms with slope angle of 7° and 10° in Hembeti and Mvomero II respectively.

Table 30: Test results for slope capability of twenty tractors

SN	Site	Slope radians [deg.]	Not Passed Tractor IDs	Passed Tractor IDs	Passed [%]
1	Mvomero I	0.2864 [$\beta = 16^\circ$]	3,4,6,12,13,15, 16,17,18,19,20	1, 2, 5, 7, 8, 9,10, 11, 14	9 (45%)
2	Mvomero II	0.1763 [$\beta = 10^\circ$]	15,17,19,20	1, 2, 3, 4,5 ,6, 7,8, 9, 10, 11,12,13, 14, 16, 18	16 (80%)
3	Hembeti	0.1227 [$\beta = 7^\circ$]	15,17,19,20	1,2,3,4,5,6,7,8,9,10,11,1 2,13,14,16,18	16 (80%)
4	The rest	0.0875 [$\beta \leq 5^\circ$]	15,17,19	1,2,3,4,5,6,7,8,9,10,11,1 2,13,14,16,18,20	17 (85%)

5.6.5 Multiple Linear regression models for predicting rearwards static overturning stability limit of tractor-plough systems

Using SPSS software Version 11.5 (2002), regression models were run to quantify the effect of the design parameters (independent variables in Table 27) on the rearwards static overturning stability limit (dependent variable). The following regression model was formulated to estimate the rearwards static overturning stability limit:

$$Y_{TS} = 2.580 - 0.177 X_1 - 0.233X_2 + 0.773X_3 + 0.487X_4 - 0.141X_5 \quad (29)$$

$$R^2 = 0.924$$

Table 31 shows that the VIF values of three independent variables were less than five which implies that no linear relationship exists between and among two or more of the

independent variables. Table 31 presents predictors influencing the rearwards stability index whereby regression was significant ($p \leq 0.001$) and the four independent variables account for 94.4% (Adjusted $R^2 = 92.4\%$) of rearwards stability index.

Table 31: Predictors influencing the rearwards stability index

Independent Variable	Un standardized Coefficients		Standardize d Coefficients	t	Sig.	Co linearity Statistics	
	B	Std. Error	Beta			Tolerance	VIF
(Constant)	1.662	0.918		1.810	0.092		
Horizontal distance from rear axle to CG of lifted plough	-0.575	0.260	-0.177	-2.213	0.044	0.627	1.595
Weight of mounted plough	-0.133	0.077	-0.233	-1.728	0.106	0.222	4.514
Tractor Weight	0.007	0.002	0.773	3.441	0.004	0.080	12.544
Horizontal distance from rear axle to CG of tractor	1.075	0.583	0.487	1.843	0.087	0.058	17.334
Height of CG of lifted plough	-0.268	0.187	-0.141	-1.435	0.173	0.417	2.401

Predictors: (Constant), Horizontal dimension from rear axle to CG of plough (X1), Weight of mounted plough (X2), Tractor Weight (X3), Horizontal distance from rear axle to CG of tractor (X4), Height of CG of plough (X5)

Dependent variable: Rearwards Stability Index

R square (R^2) = 0.944, Adjusted R Square (R^2) = 0.924, F-statistics (for R^2) = 46.942*

* = significant at .001 level

Tractor weight was the highest predictor of rearwards stability index (standardized regression coefficient of 0.773, significant at $p \leq 0.01$). The positive regression coefficient implies that, tractor weight and rearwards stability index are positively related. Increase in tractor weight leads to increase in rearwards stability index. A change of tractor weight by 1 unit translates into a change of rearwards stability index by a factor of 0.773. Plough weight had a standardized regression coefficient of -0.233, significant at about $p \leq 0.1$). The negative regression coefficient implies that, plough weight and rearwards stability index are negatively related. Increase in plough weight leads to decrease in rearwards

stability index. A change of plough weight by 1 unit translates into a change of rearwards stability index by a factor of 0.233.

Horizontal distance from rear axle to CG of lifted plough had a standardized regression coefficient of - 0.177, significant at ($p \leq 0.05$). The negative regression coefficient implies that horizontal position of the plough CG from the rear axle and rearwards stability index are negatively related. Increase in horizontal position of the plough CG from the rear axle decreases the rearwards stability index. Horizontal distance from rear axle to CG of tractor had a standardized regression coefficient of 0.487, significant at ($p \leq 0.1$). The positive regression coefficient implies that the horizontal distance from rear axle to CG of tractor and rearwards stability index are positively related. Increase in the horizontal distance from rear axle to CG of tractor leads to increase in rearwards stability index. Height of CG of plough had a standardized regression coefficient of - 0.141, significant at ($p \leq 0.2$). This indicates that it has no significance. The negative regression coefficient implies that, the height of CG of plough and rearwards stability index are negatively related. Increase in the Height of CG of plough leads to decrease in rearwards stability index.

5.6.6 Multiple regression models for predicting sideways static overturning stability limit of tractor-plough system

Using SPSS software Version 11.5 (2002), regression models were run to quantify the effect of the design parameters (independent variables) on the sideways static overturning stability limit (dependent variable). The following regression model was formulated to estimate the sideways static overturning stability limit:

$$Y_{SS} = 1.293 + 0.318X_1 - 0.308 X_2 + 0.813X_3 - 0.097X_4 \quad (30)$$

Findings presented in Table 30 show that the VIF values were less than five which implies that no linear relationship existing between and among two or more of the independent variables. Table 32 presents predictors influencing the sideways stability index whereby regression was significant ($p \leq 0.01$) and the four independent variables account for 99.6% (Adjusted $R^2 = 99.1\%$ of rearwards stability index). Further findings show that three independent variables included in the analysis are significant at ($p \leq 0.001$) regression coefficients and the remaining independent variable is significant at ($p \leq 0.01$) regression coefficient.

Average Wheel Track was the highest predictor of sideways stability index (standardized regression coefficient of 0.813, significant at $p \leq 0.01$). The positive regression coefficient implies that average wheel track and sideways stability index are positively related. Increase in average wheel track leads to increase in sideways stability index. A change of average wheel track by 1 unit translates into a change of sideways stability index by a factor of 0.813.

Table 32: Predictors influencing the sideways stability index

Independent Variable	Un standardized Coefficients		Standardized Coefficients		Co linearity Statistics	
	B	Std. Error	Betat	Sig.	Tolerance	VIF
Constant	1.293	0.145		8.941	0.000	
Tractor Weight (kN)	0.003	0.000	0.318	6.777	0.000	0.271
Height of Tractor CG (m)	-1.158	0.097	-0.308	-12.001	0.000	0.911
Average Wheel Track (m)	0.476	0.023	0.813	20.469	0.000	0.379
Height of CG of lifted plough (m)	-0.189	0.063	-0.097	-2.999	0.009	0.574

R square (R^2) = 0.996, Adjusted R Square (R^2) = 0.991, F-statistics (for R^2) = 414.185*

* = significant at .000 level

Tractor weight had a standardized regression coefficient of 0.318, significant at ($p \leq 0.001$). The positive regression coefficient implies that the tractor weight and sideways stability index is positively related. Increase in the tractor weight leads to increase in sideways stability index. Height of tractor CG had a standardized regression coefficient of - 0.308, significant at ($p \leq 0.001$). The negative regression coefficient implies that the height of tractor CG and sideways stability index are negatively related. Increase in height of tractor CG decreases the sideways stability index.

Height of CG of plough in transport position had a standardized regression coefficient of - 0.097, significant at ($p \leq 0.01$). The negative regression coefficient implies that the height of CG of plough and sideways stability index are negatively related. Increase in the height of CG of plough leads to decrease in rearwards stability index.

5.6.7 Regression models for predicting the effect of design parameters on static stability of tractor-plough system

5.6.7.1 Introduction

The Curve Estimation procedure produced curve estimation regression statistics and related plots. For each model, the following statistics were of concern: regression coefficients, multiple R , R^2 , adjusted R^2 , standard error of the estimate. Other statistics considered are: 99%, 95% and 90%-confidence intervals for each regression coefficient.

5.6.7.2 Regression models for predicting the influence of weight of plough on rearwards static overturning stability

The best fit mathematical relationship between the maximum operating slope angle and weight of plough in Figure 24 could be represented by Equation 75.

$$Y = 41.3673 - 1.7515X + 0.0143X^2 \quad (31)$$

Where:

Y = maximum operating slope angle, [deg.]

X = Weight of plough, [kN],

The value of coefficient of determination ($R^2 = 0.99$) was the maximum and significant at 0.1 percent level ($p \leq 0.001$). Findings in Fig. 28 show that increasing weight of the mounted plough decreases the value of maximum operating slope angle β_{\max} . This implies that if two similar tractors are mounted with ploughs of equal design parameters but different weights, then their maximum operating slope angle (β_{\max}) will differ.

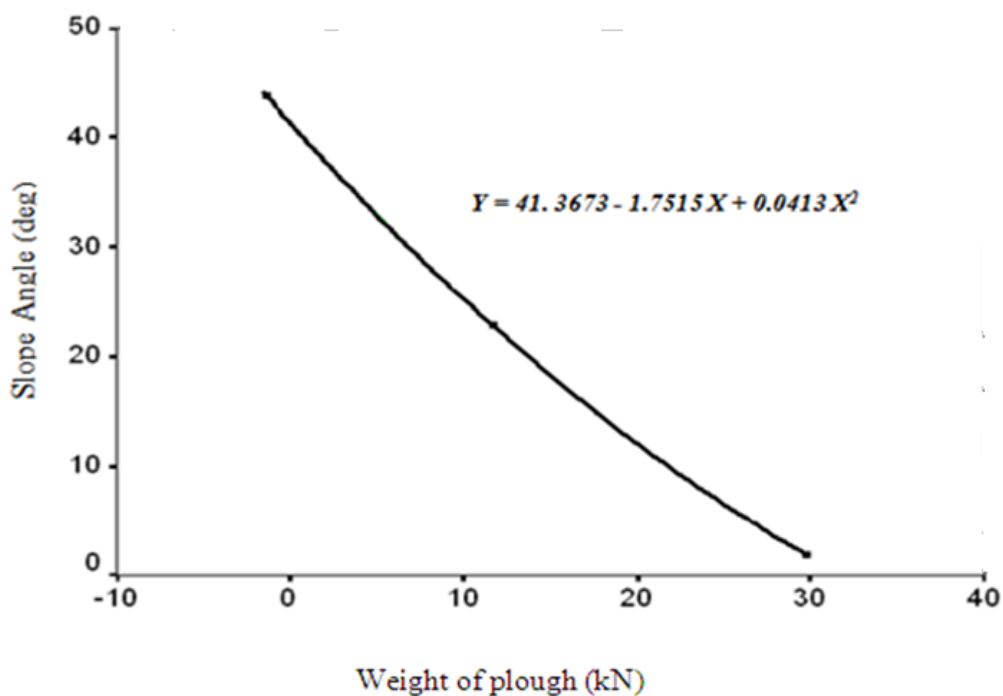

Figure 28: Fitted curves of maximum operating slope angles (β) against Weight of plough (kN)

The tractor mounted with light plough will be comparatively more stable than the one mounted with heavier plough. This phenomenon may be employed in the development of the decision support model for selection of optimum tractor-plough systems.

5.6.7.3 Regression models for predicting influence of horizontal dimension from rear axle to the centre of gravity of plough

The best fit mathematical relationship between maximum operating slope angle and the horizontal dimension from rear axle to centre of gravity of plough in Fig. 29 could be represented by Equation 76:

$$Y = 44.8891 - 3.9528 X - 0.2928 X^2 \quad (32)$$

Where:

Y = maximum operating slope angle, [deg.]

X = horizontal distance from rear axle to centre of gravity of plough [m]

The value of coefficient of determination ($R^2 = 0.99$) was the maximum and significant at 0.1 per cent level ($p \leq 0.001$).

Findings in Fig. 29 show that increasing horizontal dimension from rear axle to the centre of gravity of plough decreases the value of maximum operating slope angle β_{\max} . This implies that if two similar tractors are mounted with ploughs of equal design parameters but different position of centre of gravity from the rear axle, then their maximum operating slope angle (β_{\max}) will differ. The tractor mounted with plough having shorter dimension from the rear axle to its centre of gravity will be comparatively more stable than the one mounted with plough having larger dimensions. This has also been considered as one of the criteria in the development of the decision support model for selection of optimum tractor-plough systems.

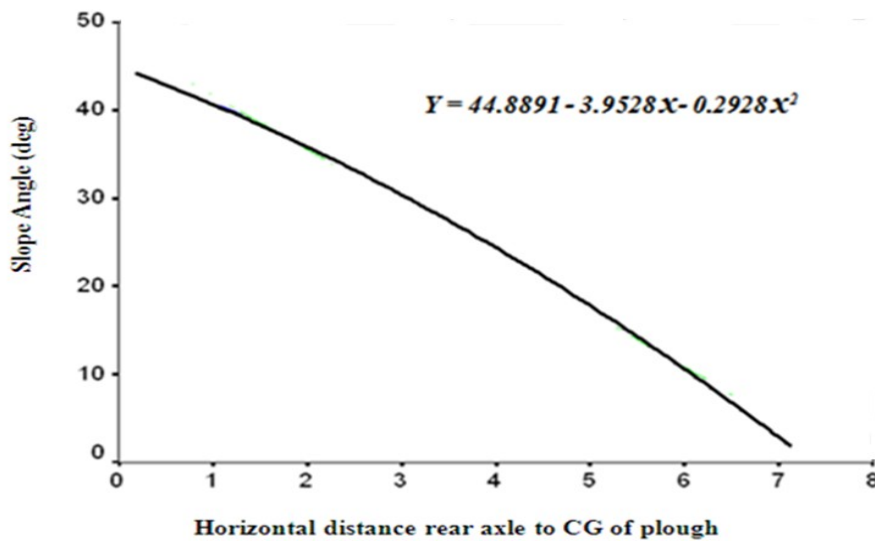

Figure 29: Maximum operating slope angles (β) Vs Horizontal dimension from rear axle to centre of gravity of mounted plough

5.6.7.4 Regression models for predicting influence of horizontal dimension from rear axle to the centre of gravity of tractor

The best fit mathematical relationship between maximum operating slope angle and the horizontal dimension from rear axle to centre of gravity of tractor in Fig. 30 could be represented by Equation 77.

$$Y = - 6.4904 + 69.2840 X - 18.535 X^2 \quad (33)$$

Where

Y = maximum operating slope angle, [deg.]

X = horizontal dimension from rear axle to centre of gravity of tractor [m]

The value of coefficient of determination ($R^2 = 0.99$) was the maximum and significant at 0.1 per cent level ($p \leq 0.001$).

Findings in Fig. 30 show that increasing horizontal dimension from rear axle to the centre of gravity of tractor increases the value of maximum operating slope angle (β_{\max}). This

means that if two similar tractors having equal design parameters except their horizontal dimension from rear axle to their centre of gravity of tractor, then their maximum operating slope angle (β_{\max}) will differ. The tractor with larger dimension from the rear axle to its centre of gravity will be comparatively more stable than the one with small dimension.

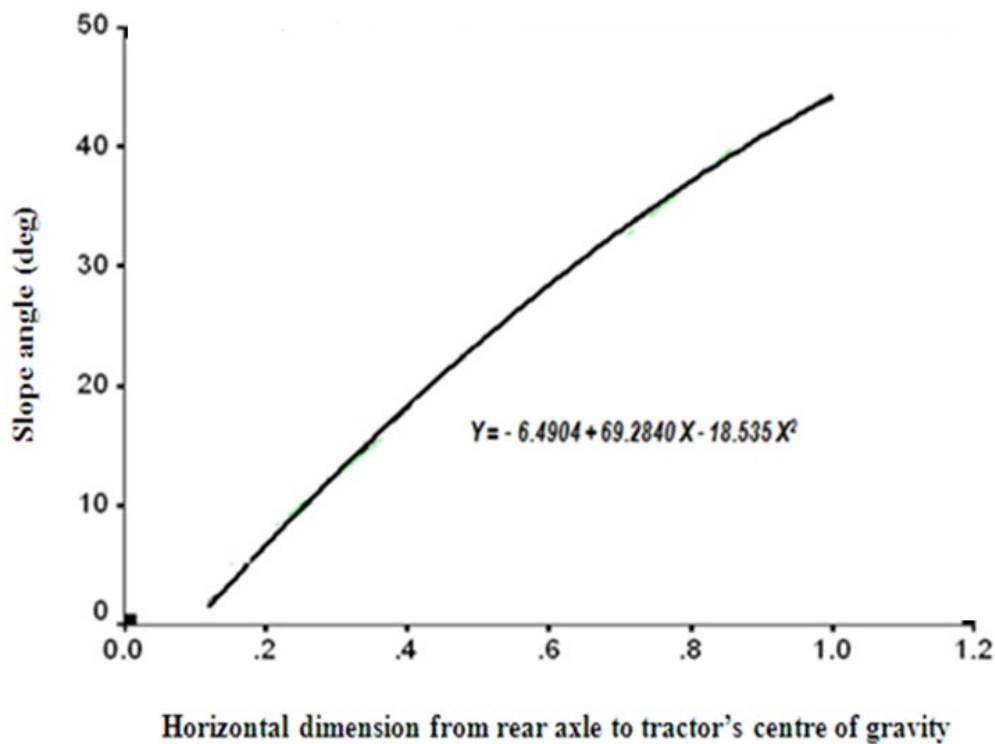

Figure 30: Fitted curve of maximum operating slope angles (β) vs horizontal distance from rear axle to centre of gravity of tractor

5.6.7.5 Regression models for predicting influence of height of the centre of gravity of tractor

The best fit mathematical relationship between maximum operating slope angle and the height of the centre of gravity of tractor could be represented by Equation 34.

$$Y = 2.2781 + \frac{34.0229}{X} \quad (34)$$

Where: $Y =$ maximum operating slope angle

$x =$ height of the centre of gravity of tractor[m]

The value of coefficient of determination ($R^2 = 0.99$) was the maximum and significant at 0.1 per cent level ($p \leq 0.001$).

Findings presented in Fig. 29 show that increasing height of the centre of gravity of a tractor decreases the value of maximum operating slope angle (β_{\max}). This means that if two similar tractors having equal design parameters except the height of their centres of gravity, then their maximum operating slope angle (β_{\max}) will differ. The tractor with small height of centre of gravity will be able to operate at comparatively steeper slope than the one with large height.

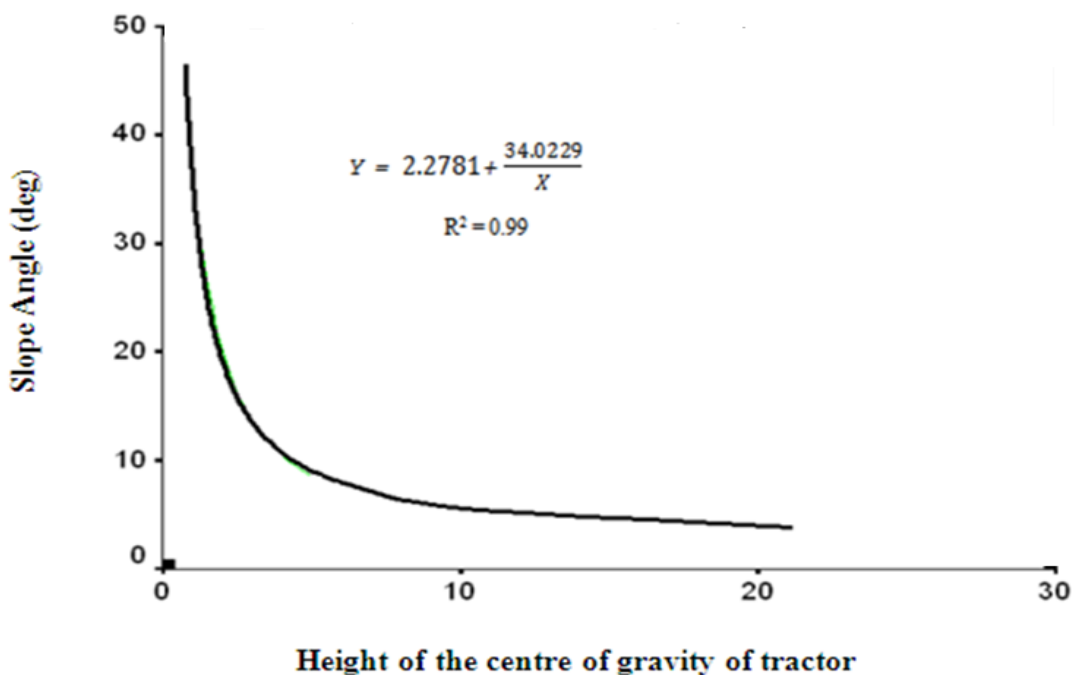

Figure 31: Maximum operating slope angles (β) Vs Height of the centre of gravity of tractor

5.6.7.6 Regression models for predicting the influence of height of the centre of gravity of mounted plough

The best fit mathematical relationship between maximum operating slope angle and the height of the centre of gravity of plough in Fig. 30 could be represented by Equation 35.

$$Y = 34.2546 - 1.4598X + 0.0195 X^2 - 0.00007 X^3 \quad (35)$$

Where:

Y = maximum operating slope angle

x = height of the centre of gravity of plough[m]

The value of coefficient of determination ($R^2 = 0.95$) was the maximum and significant at 0.1 per cent level ($p \leq 0.001$).

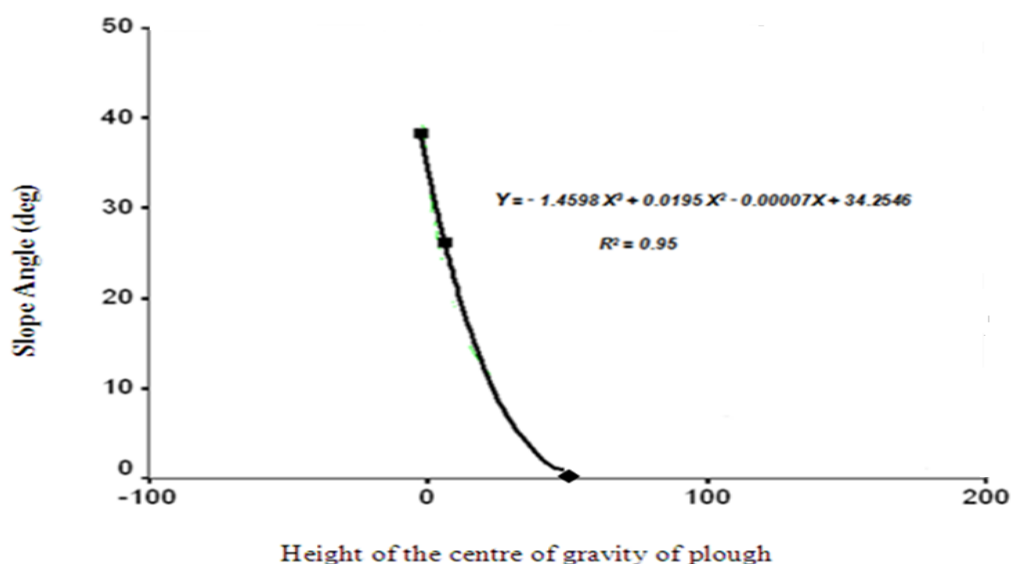

Figure 32 Maximum operating slope angles (β) Vs Height of the centre of gravity of plough.

Findings presented in Fig. 31 show that increasing height of the centre of gravity of mounted plough decreases the value of maximum operating slope angle (β_{\max}). It means that if two similar tractors having equal design parameters but mounted with ploughs

having different height of their centres of gravity in transport position, then their maximum operating slope angle (β_{\max}) will differ. The tractor mounted with a plough which has small height of centre of gravity from the ground will be able to operate at comparatively steeper slope than the one with big height.

5.7 The Computer-Based Tractor-Plough System Selection Tool

5.7.1 Introduction

The Tractor-Plough System Selection Tool (TPSST) is a computer-based decision support application written in VB6 programming Language. The developed TPSST is user friendly and the user does not need any special advanced training rather general computer literacy is the minimum requirement. The TPSST consisted of three Modules namely: Tractor Traction Simulation Module (TTSM), Tractor Static Stability Module (TSSM), and Tractor-Plough Selection Module (TPSM). The TPSST program selected tractors and ploughs to satisfy the available drawbar pull, draught, upper and lower speed requirements, static overturning stability on specified terrain slope angle, farm size and the time allotted for the operation. The program determined total annual cost of all the system and selected the lest-cost system.

5.7.2 TPSST program description

The program starts with a login screen shown in Fig. 31. The next screen which appears after login is the main window (TPSST main menu) of the program which consists of two frames and several command buttons as shown in Fig. 32.

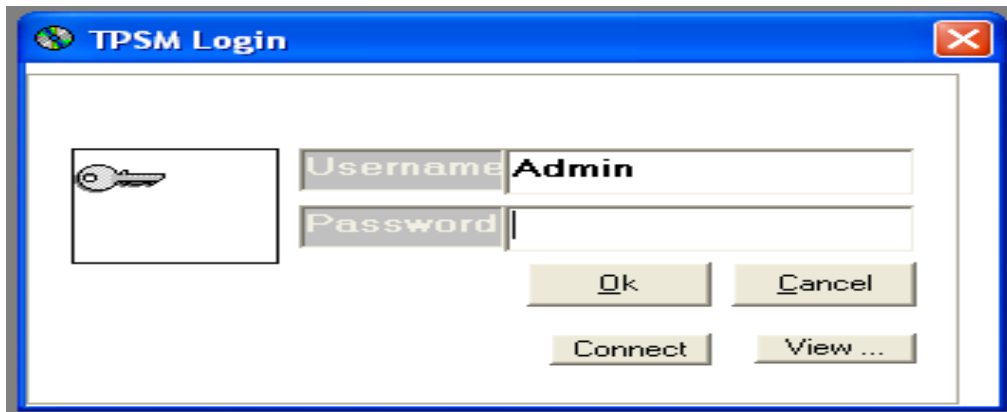

Figure 33: Screen for login.

These frames are named as 'Menu' and 'System management'. The first frame consists of six button controls namely 'Traction Simulation', 'Stability Analysis', 'Tractor and Plough Selection', 'Tractors', 'Ploughs', 'Tyres' and 'Constants'. The second frame contains four buttons: 'Configurations', 'Users management', 'about' and 'Exit.'

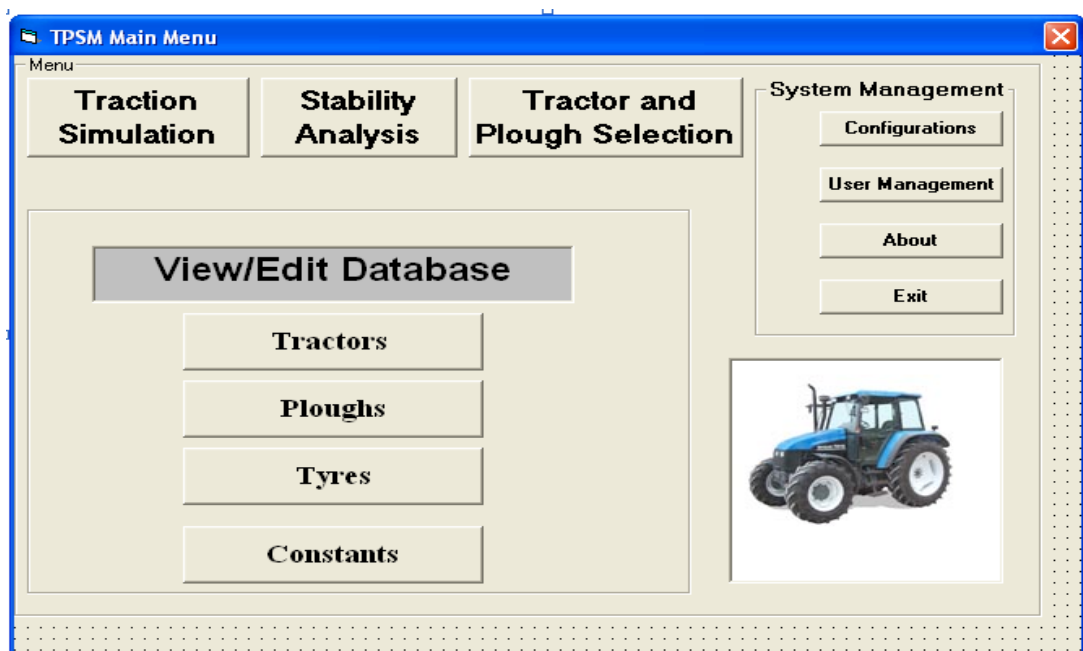

Figure 34: TPSST main menu.

Figure 32 shows specifications database screen of tractors. The tractors specifications database contains information such as make; make ID, model, model ID of a number of

agricultural tractors. The other parameters included are tractor input power, tire type and size, number of tires, static weight on front and rear axles, wheel base, draught height and angle, fuel type, distance from the rear axle, to drawbar hitching point maximum and minimum speed.

Tractor And Traction Surface

General Parameters

Make: M.Ferguson | Model: 451 | 2WD | Make ID: | Tractor ID: 1

Input Power(kW): 35 | Wheelbase(mm): 2000 | Draft Height(mm): 315 | Static Front Weight(kg): 1089

Power Efficiency(%)
Front: 96 | Rear: 96 | Draft Angle(deg): 27 | Distance Behind Rear Axle(mm): 340 | Static Rear Weight(kg): 1442

No of Front Tyres: 2 | No of Rear Tyres: 2 | Max Speed(km/h): 28

Front Tyre: 317.5 | 501.65 | Rear Tyre Size: 378.5 | 598.03 | Min Speed(km/h): 2

Dimensions

Rear Axle to C of G (Xr): 600 (mm) | Front Wheel Track (Zf): 1500 (mm)
Front Axle to C of G: 1400 (mm) | Rear Wheel Track (Zr): 1875 (mm)
Rear Axle to C of G Height (Y3): (mm) | Hitch Length: 870 (mm)
Height of C.G Tractor: 525 (mm) | Max Hitch Height: (mm)
Hitch Point to Ground: 4645 (mm) | Max Hitch Angle: 27 (deg)

Machine Costs

Purchase Price: 12600000 | Annual Fixed Cost: 5745600 | Annual Tractor Cost: 6063120
Fixed Cost Factor: 45.6 | Annual Repair Costs: 317520 | Tractor Cost Per Hour: 10105.2

... | New Tractor | Modify | Cancel | Delete | Close | First | Previous | Next | Last

Figure 35: Edit/View Window for tractor specifications database

The tractors database window in Fig. 34 also shows the design parameters as well as the costs of each tractor. The user can add new tractor specifications, modify existing specifications, cancel, delete, and close by clicking the respective command buttons

located at the bottom of the window. The command buttons which are labelled by *first*, *previous*, *next* and *last* are used for navigation in the database.

The disc plough database window is shown in Fig. 36. The window contains text boxes for inputting data of disc ploughs. Such data includes plough ID number, make, model, frame type, total weight, total width, total length, maximum power, working depth etc.

The screenshot shows a software window titled "Disc Plough Specifications" with a standard Windows-style title bar (minimize, maximize, close buttons). The window is divided into several sections:

- Plough Data:** Contains fields for "Plough Make" (Alvan Blanch), "Model" (ADP2), and "Plough ID" (1). Below this is a grid of 12 fields:

Wheel Diameter(mm)	508	Frame Type	Tubular
No of Discs	2	Total Width(mm)	1115
Total Length(mm)	1115	Total Height(mm)	1235
Work Depth(cm)	25	Work Width(cm)	86
Space of Discs(cm)	53	Disc Diameter(mm)	660
Max Power(kW)	26	Min Power(kW)	22
Total Weight(kg)	310		
- Machine Parameter(SI Units):** Contains fields for "Soil Parameter (F1)", "Soil Parameter (F2)", and "Soil Parameter (F3)", all set to "1". It also has a "Tillage Type" dropdown menu. Below these are "Speed Coefficient A" (124), "Speed Coefficient B" (6), and "Speed Coefficient C" (0).
- Machine Costs:** Contains fields for "Purchase Price" (4030000), "Annual Fixed Cost" (449,345), "Fixed Cost Factor" (11.15), "Annual Repair Cost" (44934), and "Repair Cost Per Hour" (299.56).
- Buttons:** A row of buttons at the bottom: "New" (highlighted with a dotted border), "Modify", "Cancel", "Delete", "Close", "First", "Previous", "Next", and "Last".

Figure 36: Edit/View window for disc plough specifications database.

The user can add new plough specifications, modify existing specifications, cancel, delete, and close by clicking the respective command buttons located at the bottom of the window. The command buttons which are labelled with *first*, *previous*, *next* and *last* are used for navigation in the database.

The tyre databases for bias-ply, radial and front tyres include parameters such as tyre size, section width, overall diameter, static loaded radius, rated capacity, ply rating for bias-ply or symbol marking for radial, and tread code. A screen of this database is shown in Fig. 35.

The screenshot shows a software window titled "Bias-Ply Tyres Data". At the top, there are two dropdown menus: "Tyre Type" set to "Bias-Ply" and "Tyre ID" set to "2". Below this is a section labeled "Tyre Data" containing several input fields:

- Tyre Size:** A field with "19" in a box labeled "b", a bold "B" in a box, and "35" in a box labeled "NRD".
- Size Factor:** A field with the formula $= b \times 10 + \text{NRD}/100$ and the value "190".
- Rated Capacity(kg):** 16
- Section Width(mm):** 3223
- Ply Rating:** 34
- Overall Diameter(mm):** 12312
- Tread Code:** R-6
- Static Loaded Radius(mm):** 232

At the bottom of the window, there is a row of buttons: "Add Tyre", "Modify", "Cancel", "Delete", "Close", "First", "Previous", "Next", and "Last".

Figure 37: Edit/View window for tyre specifications database

The user can add new tyre specifications, modify existing specifications, cancel, delete, and close by clicking the respective command buttons located at the bottom of the window. The command buttons which are labelled with *first*, *previous*, *next* and *last* are used for navigation in the database.

The traction constants database screen is shown in Fig. 38 and contains the coefficients for bias-ply and radial tires. The coefficients for radial tires used in the model were the mean values recommended by Brixius (1987). The user can change the values of the coefficients in the database.

The screenshot shows a window titled "Traction Constants" with a table of data and several input fields and buttons below it.

Const ID	Const Name	Radial	Bias
14	C1	0.03	0.40
15	C2	0.88	0.88
16	C3	0.10	0.10
17	C4	0.50	0.50
18	C5	0.90	1.00
19	C6	3.00	3.00
20	C7	5.00	5.00
21	C8	9.50	7.50

Below the table, there are input fields for "ID", "Const Name", "Radial", and "Bias". At the bottom, there are buttons for "New", "Modify", "Delete", "Cancel", and "Close".

Figure 38: Edit/View Window for Tractor's Traction Coefficients.

Fig. 37 shows input window for tractor performance prediction. The input window is linked to the tractor specifications database and in effect linked to the otherspecifications database screen of a tractor. The tractor specification database contains information such as make; make ID, model, model ID of a number of agricultural tractors. The other parameters included are tractor input power, tire type and size, number of tires, static weight on front and rear axles, wheel base, draught height and angle, fuel type, distance behind rear axle, maximum and minimum speed.

Simulation Parameters

Tractor Performance Parameters | Tractor Performance Results

Tractor : M.Ferguson-451

Make: M.Ferguson | Model: 451 | 4WD | Make ID: | Tractor ID: 1

Input Power (kW): 35 | Wheelbase (mm): 2000 | Draft Height (mm): 315 | Static Front Weight (kg): 1089

Power Efficiency (%):
 Front: 96 | Rear: 96 | Draft Angle (deg): 26.99310344827 | Distance Behinde Rear: 340 | Static Rear Weight (kg): 1442

No of Fornt Tyres: 2 | No of Rear Tyres: 2

Front Tyre: 317.5 | 501.65 | Rear Tyre Size: 378.5 | 598.03

PTO (hP): 45 | DRAFT (hP): 0

Max Speed (km/h): 28 | Min Speed (km/h): 2 | Soil Cone Index (kPa): | Operating speed (km/hr): 0

Fuel Type: Diesel

First Previous Next Last Close

Figure 39: Input window for tractor performance prediction.

The soil parameter, cone index value may be input or changed to the database window. The program simulates traction performance parameters for each selected tractor in the input window in Fig. 39. The next window in Fig. 40 was designed to contain a frame which encloses tractor performance prediction results such as traction dynamic weight, mobility number, gross traction ratio, motion resistance ratio, net traction ratio, wheel slip, actual speed, and drawbar pull.

The screenshot shows a software window titled "Simulation Parameters" with two main tabs: "Tractor Performance Parameters" and "Tractor Performance Results".

Tractor Performance Parameters (Left Panel):

- Dynamic Weight(kg): 2531
- Mobility Number: 6206.47
- Gross Traction Ratio: 0.63
- Motion Resistance Ratio: 0.03
- Net Traction Ratio: 0.6
- Drawbar Pull(kN): 15.15
- Actual Speed(km/h): 0
- Drawbar Power(kW): 0

Tractor Performance Results (Right Panel):

Model Used For This Simulation: M. Ferguson-451

Fuel Consumption:

- Fuel Type: Diesel
- Fuel Consumption(Lt/kW-hr): 0
- SVFE: 0
- SVFC: 0
- Qave: 0

Dimensions (Bottom Left):

- Rear Axle to C of G (Xr): 600 (m)
- Front Axle to C of G: 1400 (m)
- Rear Axle to C of G Height (Y3): (m)
- Height of C.G Tractor: (m)
- Hitch Point to Ground: 4645 (m)

Dimensions (Bottom Middle):

- Front Wheel Track (Zf): 1500
- Rear Wheel Track (Zr): 1875
- Hitch Length: 870
- Max Hitch Angle: 27

Costs (Bottom Right):

- Machine Price: 12600000
- Variable Cost: (empty field)

Figure 40: Window for displaying traction performance prediction results.

The command buttons which are labelled by *first*, *previous*, *next* and *last* are used for selecting tractor and navigation in the database.

A tractor of a particular model can be selected from a tractor selection database, which contains a number of tractors manufactured by different companies and the corresponding model number. This database is linked to the tractor specifications database and in effect linked to the other databases. Corresponding to a selected tractor and model, the various inputs from the different databases can be fed to the tractor parameters calculation part of the program.

Clicking the 'Tractor-Plough Selection' button in the window shown in Fig.34 the control is transferred to the screen shown in Fig. 41.

Inputs		Simulation Results	
Total Area(Ha)	100	Field Capacity (Ha/hour)	
Alloted Time(Days)	8	Implement Width(m)	
Average Hours Per Day	8	Total Draft(kN)	
Operating Speed(km/hr)	8	Drawbar Power Required(kW)	
Operating Depth(cm)	10	Tractor PTO Power(kW)	
Unit Draft(kN/m)	0.55	Tractor PTO Power (hp)	
Farm Slope(deg)	10		
Soil Cone Index(kPa)	1200		
Farm Soil Texture			
Traction Surface			

Figure 41: Data input window for selection of optimum tractor - plough systems.

The screen contains two frames and three buttons. The first frame encloses eight text boxes and two combo boxes control objects for data input and three command buttons: *Simulate*, *Clear* and *Close*. This program contains a default data on various parameters like allotted time (days), farm area, depth of cut, soil texture, daily work hours, operating speed, plough and unit draught as shown in Fig. 41. However, if user wants to use his/her own data there is a provision for changing by entering own data in the program. You may also input farm slope in degrees and select a different soil texture by clicking the combo-boxes. The second frame contains six text boxes for displaying running simulation results. The Selected tractor-plough systems are displayed in the window shown in Fig. 42.

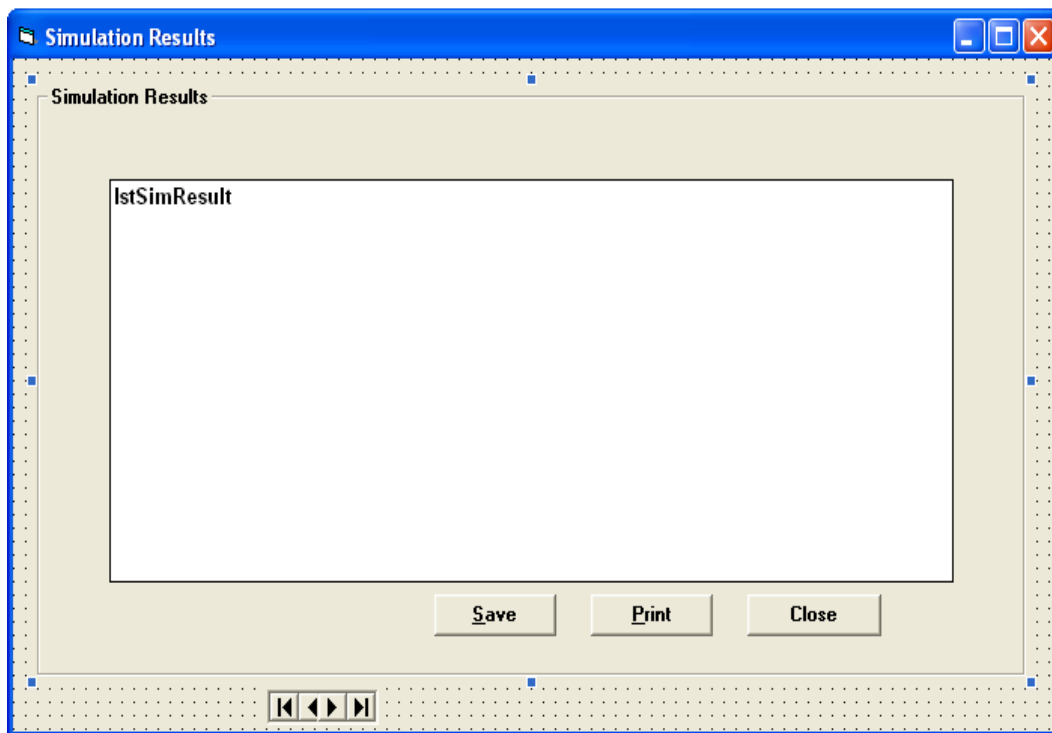

Figure 42: Window for display of tractor and plough selection results.

5.7.3 TPSST validity

The most definitive test of the TPSST's validity was establishing that its output data closely resemble the output data that observed from the actual system in the study area.

The mean tractor power in the study area was observed to be 44 kW (55 hp).

The power of tractors (in kW) selected by the TPSST for farm sizes ranging from 1ha to 24ha were as follows: 18, 21, 28, 13, 47, 45, 32, 21, 37, 58, 50, 72, 47, 54 and 102. Using the Student's t-statistic, test was carried out to test whether the mean power of tractors selected by TPSST was taken to be 44 kW (tested at 5 per cent significance). Taking the null hypothesis that the population mean is equal to hypothesized mean of 44 kW and the alternate hypothesis that the population mean is not equal to the hypothesized mean. In other words the null (H_0) and alternate (H_a) hypothesis were stated as follows:

H ₀ :	There was no significant difference between the observed and predicted tractor size.
H _a :	The observed and predicted tractor size was significantly different.
H ₀ : μ _o :	μ = μ _{H₀} = 44 kW
H _a : μ _a :	μ ≠ μ _{H₀} ≠ 44 kW

The findings showed in Table 33 that the differences between the predicted and observed tractor power for all the categories of farm sizes were statistically insignificant. This led to a conclusion that the tool prediction was good for the farmers of the study area.

Table 33: Test statistic, t of observed and predicted tractor power

n	df = (n-1)	Sign.	$t = \frac{X - \mu_{H_0}}{\sigma\sqrt{n}}$	Probable value of t read from a table	Reject if (R) : t > τ
16	15	5%	-0.27578	1.753	Accept

5.7.4 Application of TPSST to select optimum tractor-plough system

TPSST was tested to select an optimum tractor-plough system for a farm of 100 ha within allotted time in the study area. Farm equipment systems were determined for a 100 ha farm in the Mvomero District. The effects of alternative wage rates in TZS (3 000, 4 000 and 5 000 per hour), Soil texture (Fine, medium and coarse), Fuel price in TZS (1 000, 2 000, 3 000) on the equipment systems and total annual costs were evaluated. Also, the effects of various farm sizes (1 ha to 20 ha) on the equipment systems and total annual costs were estimated.

The selection results presented in Table 34 shows the list of alternative sets of selected tractor and plough combinations that could cultivate a farm of 100 hectares and satisfied

all the conditions and requirements together with the annual costs. More selection results are presented in Appendices 10-14.

In Table 34 the list is presented in ascending order i.e. from the least total annual costs to the highest total annual costs. The identity of the selected tractor and plough is a combination of make, model and ID number, for example the identification of N.Holland /TV6070/14 is defined as follows: N. Holland stands for the name/make of the tractor, TV6070 stands for model of the tractor and finally 14 is the ID number of the tractor.

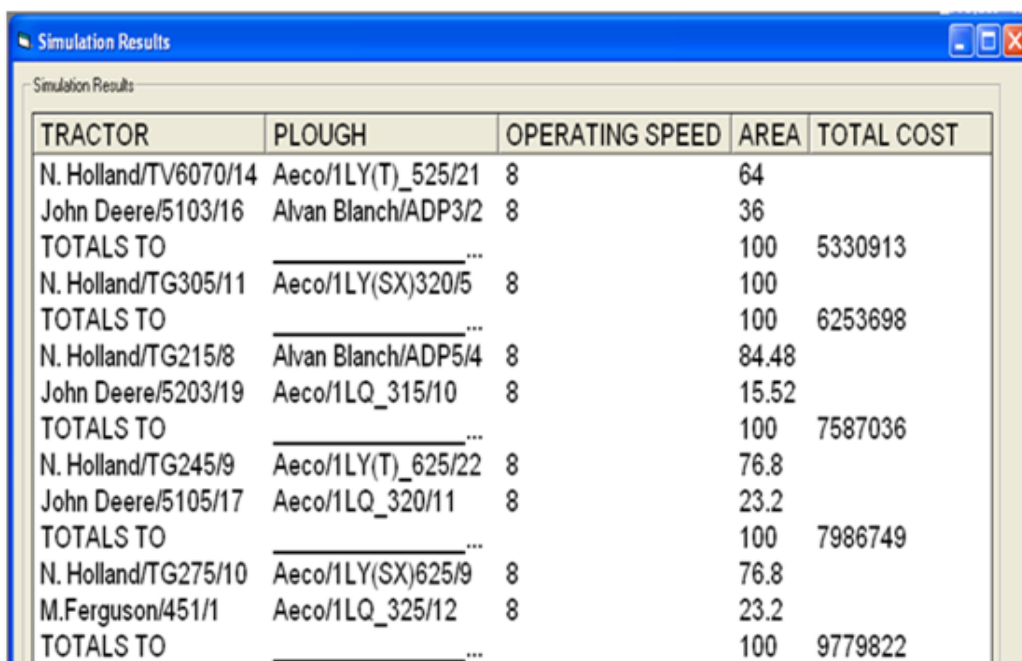

TRACTOR	PLOUGH	OPERATING SPEED	AREA	TOTAL COST
N. Holland/TV6070/14	Aeco/1LY(T)_525/21	8	64	
John Deere/5103/16	Alvan Blanch/ADP3/2	8	36	
TOTALS TO	---		100	5330913
N. Holland/TG305/11	Aeco/1LY(SX)320/5	8	100	
TOTALS TO	---		100	6253698
N. Holland/TG215/8	Alvan Blanch/ADP5/4	8	84.48	
John Deere/5203/19	Aeco/1LQ_315/10	8	15.52	
TOTALS TO	---		100	7587036
N. Holland/TG245/9	Aeco/1LY(T)_625/22	8	76.8	
John Deere/5105/17	Aeco/1LQ_320/11	8	23.2	
TOTALS TO	---		100	7986749
N. Holland/TG275/10	Aeco/1LY(SX)625/9	8	76.8	
M.Ferguson/451/1	Aeco/1LQ_325/12	8	23.2	
TOTALS TO	---		100	9779822

Figure 43: Tractor-plough system's selection results.*

*Input data:

Total area = 100 ha, Medium textured and previous tilled soil, Allotted time = 8 days, Average working hours per day = 8 hours, Operating speed = 8 km/h, Wage for operator = 5000/- per hectare, Fuel cost per litre = 2000/-, Cone Index = 1200 k Pa, Operating depth and width of cut = depended on the matched plough.

The least-cost set of tractor-plough combinations was the first one in the list which consisted of two tractors: (N. Holland/TV6070/14 and John Deere/5103/16) each attached with a matched plough (Aeco/1LY (T) _525/21 and Alvan Blanch /ADP3/2 respectively).

The simulation output also included the area cultivated by each combination of tractor and plough which was 64 ha and 36 ha respectively. The annual total cost of this set of equipment was TZS 5 330 913.00. The details of performance parameters predicted for this set of farm machinery are presented in Table 35. A summary of predicted performance parameters for each selected set of tractor-plough combinations (Table34) are presented in Appendix 9. More results of test runs carried out under different conditions (Fuel cost, wage of operator per acre, and draught requirement) are presented in Appendices 10-14.

The TPSST has an option for recommending new tractor size (power) and width of implement to till a given farm size within allotted time. For example the TPSST selected the following powers of tractor (in kW): 4, 8, 14, 18, 22, 26, 32, 36, 40, 44, 54, 66 and 88 to till, in one day, the following farm sizes (in ha): 1, 2, 3, 4, 5, 6, 7, 8, 9, 10, 12, 15, and 20 respectively. The simulated widths of cut (in meters) were: 0.2, 0.4, 0.5, 0.7, 0.9, 1.1, 1.2, 1.4, 1.6, 1.8, 2.1, 2.7 and 3.6 respectively. The simulation was executed under the following given data: Operating speed = 8 km/h, operating depth = 10 cm, average hours per day = 10 h, soil texture = medium (loamy), traction surface = previous tilled soil, unit draught = 0.55 (kN/m) and farm slope =almost flat ($0^0 - 5^0$).

Table 34: Performance parameters predicted for the selected stable and least-cost set of farm machinery

Parameters	Combination 1	Combination2
	Tractor: N. H/TV6070/14 Plough: A./1LY (T)525/21	Tractor: J D/5103/16 Plough: AB/ADP3/2
Tractor PTO Power [kW]	74	31
Max Drawbar Pull [k N]	32	12
Working Width [m]	1.25	0.99
Working Depth [cm]	30	25
Draught Requirement [k N]	26	4
Tractor Weight [kg]	6976	2218
Rearwards stability	0.738 > Tan B = 0.176	0.351 > Tan B = 0.176
Sideways stability	1.119 > Tan B = 0.176	1.404 > Tan B = 0.176
Operating Speed [km/h]	8	8
Cultivated Area[ha]	64	36
Mobility Number (BN)	29.2	52.6
GTR	0.6	0.63
MRR	0.074	0.057
MRRup	0.054	0.054
NTR	0.463	0.524
Field capacity [Ha/hr]	1	0.792
Fuel consumption per hour [l/h]	16.5	6.9
Used Time[hours]	64	45
Used Fuel [litres]	1056	313.6
Fuel cost per hour[TZS]	33000	13800
Lubricant cost per hour [TZS]	4950	2070
Plough repair cost per hour [TZS]	312.81	341.81
Plough annual fixed cost/hour [TZS]	469209	512720
Tractor cost per hour [TZS]	668	4143
Sub -Total Cost: [TZS]	3665720	1665193
GRAND TOTAL COST [TZS]		5,330,193

CHAPTER SIX

6.0 CONCLUSION AND RECOMMENDATIONS

6.1 Introduction

This chapter presents conclusion, and recommendations based on main findings of this study. The overall objective of this study was to develop a computer-based decision support tool for selection of optimum tractor-plough systems in Mvomero District. More specifically the study was undertaken (i) to analyse the status of agricultural mechanization practices (in terms of farm machinery choice, acquisition mechanisms and utilization) in selected villages of Mvomero District(ii) to determine soil physical properties, terrain gradients and related field performance parameters for selecting optimum tractor-plough system (iii) to develop mathematical models for predicting static overturning stability and field performance parameters of tractor -plough system(iv) to develop computer program for selection of optimum tractor-plough system with respect to field performance parameters, static overturning stability, and total annual costs (v) to validate the developed computer program.

6.2 Conclusion

6.2.1 The status of agricultural mechanization in the Study area

The findings have shown that, majority of smallholder famers (95.8%) use own fund and informal credit as their source of finance for farming operations. Farming and provision of tractor hiring service were the major sources of income in the study area (72.1%).Majority of smallholder farmers own small farms of 4 hectares and below(98 %). Most of tractors in the study area are aged (above 15 years old). About 51% of them were in good condition while about 34% of them were in fairly good condition with mean field capacity of 0.55 hectare per hour. Majority of tractors and implements were acquired through

dealers' credit and mechanization program (77.6%) while the rest used their own funds. Despite the small farms owned by smallholder farmers in Mvomero division, majority (66%) preferred big tractors with engine power of 60 kW (80 hp) and above. In choosing tractor, smallholder farmers (15.3%) gave first priority to availability of spare parts followed by tractor price criterion (12.7%) and tractor durability criterion (12.7 %). Other criteria with their respective scores in brackets include: low fuel consumption (9.3%), power efficiency (5.1%) and prior experience (1.7%).

The formulated mechanization development indicators have shown that the value of MI for majority (85.6%) farmers was less than 0.021 whereas the obtained value of MD for about seventy five per cent (75.4%) of farmers was less than 0.40. The formulated level of mechanization (LOM) in the district was 0.015 kW/ha. This was equal to the mechanization level of the country which was estimated at 0.015 kW per hectare. However, this value was twice higher than the estimated regional level of mechanization which was 0.008 kW/ha. The low level of agricultural mechanization in the study area may be attributed to several factors including, high cost of agricultural machinery, limited access to agricultural credit, lack of well-trained operators and mechanics for agricultural machinery, small and often scattered farm plots for optimal and effective use of draught power technology, lack of capital to invest into or hire expensive farm machineries, lack of knowledge on proper use of farm machineries which results to poor quality works, poor condition of most farms due to presence tree stumps, stones, and ridges for effective operation of farm tractors, limited availability of spare parts especially from shops at district levels, presence of poor quality spare-parts in the market. The findings have shown that mechanical operations were limited only to tillage operations such as ploughing, and harrowing. Other operations like planting, weeding, fertilizer application and harvesting are mainly manually done. The major conclusion that can be made from the findings is

that the low level of agricultural mechanization in the study area had been influenced by the above stated weaknesses and challenges surrounding the farming community in the study area. In the context of literature review this is a common situation in the whole country at large.

6.2.2 Soil physical properties, terrain gradients and related field performance parameters of tractor-plough system

The mean values of clay, silt and sand soil in the study area were 45%, 2.8% and 52.4% respectively. The mean value of cone index was 1.85 MPa and the mean value of moisture content and bulk density was 6.98% and 1.30 kg/m³ respectively. The soil conditions had influence on field performance of tractor-implement systems. Soil strength parameters were the major factors affecting the supporting, shear, friction and other abilities of the soil under the tractor load (Yu, 2006). The prediction of tractor traction performance, to large extent, depended on the proper evaluation and measurement of the strength parameters (cone index) of the terrain.

The cone index constitutes a compound parameter reflecting the comprehensive influence of shear, compression and even soil–metal friction. The equation of draught (13) presented in section 2.3.3 indicates how soil texture factors (F1, F2 and F3), bulk density coefficients (B, C), cone index factor (A) and operating width (W) and depth (T) influenced the draught force.

The cone index was used to calculate a dimensionless, tyre mobility number. The soil-tyre numeric was correlated with traction performance parameters for tyres. Among the parameters used in this equation, rolling resistance was a parameter often correlated with the soil-tyre numeric.

The mean values of field performance parameters of tractor-plough system obtained under determined soil physical properties and terrain characteristics in the study area include: draught power requirement (18.12, kW), wheel slip (4.55 %), rolling resistance (3.13kN), theoretical field capacity (0.67 ha/h), actual field capacity (0.48 ha/h), field efficiency (71%), and actual ploughing speed (7.38Km/h). The obtained values of soil physical properties, terrain characteristics and field performance parameters form an important data base for planning and selection of suitable tractor-plough combinations in the study area. The TPSST results demonstrated that just a small tractor powered by engine of 30 kW (40 hp) could effectively suffice the operation of a three-disc plough in the study area.

6.2.3 Mathematical models for predicting field performance parameters and static overturning stability limits of tractor-plough system

6.2.3.1 Regression models for predicting draught power

Assessing the strength of the relationship between variables involved the following variables: (i) dependent variable representing draught power and (ii) independent variables representing: Moisture content, cone index, width of cut, depth of cut, draught force, rolling resistance, and working speed. The following regression model was formulated to estimate the draught power:

$$Y_{dp} = -22.710 - 0.265X_1 + 0.090X_2 + 0.154X_3 - 0.069X_4 + 0.913X_5 + 0.328X_6 + 0.678X_7$$

Draught force was the highest predictor of draught power (standardized regression coefficient of 0.913). draught force and draught power are positively related. Working speed had a standardized regression coefficient of 0.678. The positive regression coefficient implies that working speed and draught power are positively related. Increase in working speed increases draught power. Higher speeds involve greater acceleration of the soil and that soils are slightly stronger under dynamic conditions. Hence implements

such as disc ploughs that lift and move soil a greater distance and have large draught due to friction and adhesion show a greater increase in draught with speed (Macmillan 2002). Soil moisture content had a standardized regression coefficient of - 0.265. Moisture content and draught power are negatively related. Increase in moisture content leads to decrease in draught power. Soil cone index had a standardized regression coefficient of 0.090. Soil cone index and draught power are positively related. Increase in soil cone index leads to increase in draught power.

Width of cut had standardized regression coefficients of 0.154. Width of cut and draught power are positively related. Increase in width of cut leads to increase in draught power. Depth of cut had standardized regression coefficients of - 0.069. Depth of cut and draught powers is negatively related. This is unexpected relationship because an increase in depth of cut would lead to an increase of draught due to increased load (soil resistance). Variation in soil texture and bulk density could be the possible cause of this shortfall. Large depth of cut in less compacted soil required small draught force, whereas small depth of cut in highly compacted clay soil required big draught force. Rolling resistance had standardized regression coefficients of 0.328. Rolling resistance and draught power are positively related. Increase in draught power leads to increase in rolling resistance due to addition on the rear tyres resulted from vertical component of draught force.

6.2.3.2 Linear regression models for predicting fuel consumption

Regression models were run to quantify the effect of independent to. The independent variables included: moisture content, variables contributing cone index, and width of cut, depth of cut, draught force, rolling resistance and working speed. The following regression model was formulated to estimate the fuel consumption:

$$Y_{fc} = 8.029 - 0.404X_1 - 0.075X_2 - 0.287X_3 - 0.535X_4 + 1.282X_5 - 0.138X_6 + 0.049X_7.$$

Draught force was the highest predictor of fuel consumption (standardized regression coefficient of 1.282) draught force and fuel consumption are positively related. Increase in draught force leads to increase in fuel consumption. Working speed had a standardized regression coefficient of 0.049. Working speed and fuel consumption are positively related. Increase in working speed increases fuel consumption. Soil moisture content had a standardized regression coefficient of - 0.404. Moisture content and fuel consumption are negatively related. Increase in moisture content decreases fuel consumption due to the fact that moist soils shear easily hence decreasing implement draught force which in turn decreases fuel consumption. Soil cone index, width of cut, depth of cut and rolling resistance had standardized regression coefficients of - 0.075, - 0.287, - 0.535 and -0.138 respectively. The negative regression coefficients imply that both independent variables and fuel consumption are negatively related. Increase in width of cut, depth of cut and rolling resistance unexpectedly led to the decrease in fuel consumption. Theoretically it was expected that, increase in width of cut, depth of cut and rolling resistance would lead to an increase in fuel consumption. Possibly the tractor engine could have been insensitive to small changes of loads caused by small changes in depth of cut, width of cut or rolling resistance due to malfunction in the fuel injection system as the engine was not tuned up and tested before using it in experiments. Inconsistence setting of the required gear ratios and engine speed during test operation could be another reason. The required setting of tractor engine speed for fuel consumption measurement was 2000 rpm at a gear ratio position H1 (High 1). The above stated anomalies imply that there is a need of further studies to identify the real causes of the anomalies.

6.2.3.3 Linear regression models for predicting rearwards static overturning stability

limit of tractor-plough systems

Using SPSS software Version 11.5 (2002), regression models were run to quantify the effect of the design parameters on the rearwards static overturning stability limit. The following regression model was formulated to estimate the rearwards static overturning stability limit:

$$Y_{rs} = 2.580 - 0.177 X_1 - 0.233X_2 + 0.773X_3 + 0.487X_4 - 0.141X_5 \quad (1)$$

Tractor weight was the highest predictor of rearwards stability index had regression coefficient of 0.773. Tractor weight and rearwards stability index are positively related. Increase in tractor weight leads to increase in rearwards stability index. Plough weight had a standardized regression coefficient of - 0.233. Plough weight and rearwards stability index are negatively related. Increase in plough weight leads to decrease in rearwards stability index. Horizontal distance from rear axle to CG of lifted plough had a standardized regression coefficient of - 0.177. Horizontal distance of from the rear axle to the plough CG and rearwards stability index are negatively related. Increase in horizontal position of the plough CG from the rear axle decreases the rearwards stability index. Horizontal distance from rear axle to CG of tractor had a standardized regression coefficient of 0.487. The horizontal distance from rear axle to CG of tractor and the rearwards stability index are positively related. Increase in the horizontal distance from rear axle to CG of tractor leads to increase in rearwards stability index. Height of CG of plough had a standardized regression coefficient of - 0.141. The height of CG of plough and the rearwards stability index are negatively related. Increase in the Height of CG of plough leads to decrease in rearwards stability index.

6.2.3.4 Multiple regression models for predicting sideways static overturning stability limit of tractor-plough system

Using SPSS software Version 11.5 (2002), regression models were run to quantify the effect of the design parameters on the sideways static overturning stability limit. The following regression model was formulated to estimate the sideways static overturning stability limit:

$$Y_{SS} = 1.293 + 0.318X_1 - 0.308 X_2 + 0.813X_3 - 0.097X_4 \quad (2)$$

Wheel Track was the highest predictor of sideways stability index (standardized regression coefficient of 0.813). wheel track and sideways stability index are positively related. Increase in average wheel track leads to increase in sideways stability index. Tractor weight had a standardized regression coefficient of 0.318. The tractor weight and sideways stability index is positively related. Increase in the tractor weight leads to increase in sideways stability index. Height of tractor CG had a standardized regression coefficient of - 0.308. The height of tractor CG and sideways stability index are negatively related. Increase in height of tractor CG decreases the sideways stability index. Height of CG of plough in transport position had a standardized regression coefficient of - 0.097. The height of CG of plough and sideways stability index are negatively related. Increase in the height of CG of plough leads to decrease in rearwards stability index.

6.2.3.5 Curve estimation between design parameter and rearwards static overturning stability limit of tractor-plough system

The best fit mathematical relationship between the maximum operating slope angle (Y) and weight of plough (X) could be represented by the following quadratic function:

$$Y = 41.3673 - 1.7515X + 0.0143X^2 \quad (3)$$

Increasing weight of the mounted plough decreases the value of maximum operating slope angle (Y). This implies that if two similar tractors are mounted with ploughs of equal design parameters but different weights, then their maximum operating slope angle (Y) will differ. The tractor mounted with light plough will be comparatively more stable than the one mounted with heavier plough. This phenomenon was employed in the development of the decision support model for selection of optimum tractor-plough systems.

The best fit mathematical relationship between maximum operating slope angle (Y) and the horizontal dimension from rear axle to centre of gravity of plough (X) could be represented by the following quadratic function:

$$Y = 44.8891 - 3.9528 X - 0.2928 X^2 \quad (4)$$

Increasing horizontal dimension from rear axle to the centre of gravity of plough (X) decreases the value of maximum operating slope angle (Y). The tractor mounted with plough having shorter horizontal dimension from the rear axle to its centre of gravity will be comparatively more stable than the one mounted with plough having larger dimensions.

The best fit mathematical relationship between maximum operating slope angle (Y) and the horizontal dimension from rear axle to centre of gravity of tractor (X) could be represented by following quadratic function:

$$Y = - 6.4904 + 69.2840 X - 18.535 X^2 \quad (5)$$

Increasing horizontal dimension from rear axle to the centre of gravity of tractor (X) increases the value of maximum operating slope angle (Y) i.e. increases the rearwards stability limit of the tractor-plough system.

The best fit mathematical relationship between maximum operating slope angle (Y) and the height of the centre of gravity of tractor (X) could be represented by the following inverse function:

$$Y = 2.2781 + \frac{34.0229}{X} \quad (6)$$

Increasing height of the centre of gravity of a tractor (X) decreases the value of maximum operating slope angle (Y). The tractor with small height of centre of gravity will be able to operate at comparatively steeper slope than the one with large height.

The best fit mathematical relationship between maximum operating slope angle (Y) and the height of the centre of gravity of plough (X) could be represented by the following cubic function:

$$Y = 34.2546 - 1.4598X + 0.0195 X^2 - 0.00007 X^3 \quad (7)$$

Increasing height of the centre of gravity of mounted plough (X) decreases the value of maximum operating slope angle (Y). The tractor mounted with a plough which has small height of centre of gravity from the ground will be able to operate at comparatively steeper slope than the one with big height.

The developed static stability and field performance prediction mathematical models formed a basis (criteria) for the development of a computer model for selection of optimum tractor- plough system. The use of computer analysis provides a significant

improvement in predicting the effect of soil physical properties, slope angle and tractor-plough system's design features on the system static stability and field performance factors. The computer analysis indicated that the static stability of tractor-plough system operating on slopes may be improved by increasing wheel base (X), tractor weight (W_t), and horizontal distance from the rear axle to the centre of gravity (X_r). The analysis also indicated that the static stability decreases with the increase of slope angle (β), the centre of gravity height of both the tractor (h_t) and plough (h_p), horizontal distance from rear axle to the centre of gravity of the plough (X_g) and the weight of the plough (W_p).

6.2.4 The Computer-Based Tractor-Plough System Selection Tool

The Tractor-Plough System Selection Tool (TPSST) is a computer decision support application written in VB6 programming Language. The TPSST consists of three Modules namely: Tractor Traction Simulation Module (TTSM), Tractor Static Stability Module (TSSM), and Tractor-Plough Selection Module (TPSM). The TPSST predicts tractor traction performance parameters including Braxius Mobility Number (B_n), Gross Traction Ratio(GTR), Motion Resistance Ratio (MRR) and Net Traction Ratio (NTR).The TPSST may be used for investigating the effects of relevant parameters on tractor traction performance on different soil conditions. The TPSST received design parameters of tractor-plough system (geometrical and weight specifications) and ground slope angle as inputs and computed static overturning stability indices (limits) for all tractor-plough systems. Thus, this model can be used for investigating the different effects of parameters on tractor-plough system's stability.The TPSST identified all feasible systems of tractor and plough based on their predicted draught force, drawbar pull, ground speed, and static stability. Then the TPSST computed the costs of the identified feasible systems and arranged the identified sets of tractor-plough systems along with their respective total annual costs in ascending order starting with the least-cost sets.

The TPSST could identify two least-cost tractor-plough systems to cultivate a farm of 100 ha with specified soil conditions namely N.Holland-TV6070/Aeco-1LY (T) - 525 and John Deere-5103/AB-ADP3. The identified systems were technically feasible with respect to draught, drawbar pull, static stability limit, ground speed, field capacity, time requirements and allotted time. The results obtained, indicate that, the tool is capable of selecting, from the database, a set of matched and stable tractor-plough systems that can complete the cultivation of the given farm area with specified soil and terrain conditions within allotted time. The tool was found to be sensitive to variations of fuel price per litre, tractor operator's wage per hour and soil texture. The developed TPSST is user friendly and the user does not need any special advanced training rather general computer literacy is the minimum requirement. The TPSST is flexible and interactive to the users in agricultural research, education and consulting organizations. The model had provision for changing model parameters, editing or expanding available databases and adding new modules. The tool is capable of showing a great validity in matching the plough with tractor size available under a given soil and terrain characteristics.

6.3 Recommendations

- (i) The developed model for selection of optimum tractor- plough system was limited to 2WD tractors and disc ploughs. However, the model can be used for further studies involving 4WD tractors and other types of implements.
- (ii) The study on the stability of tractor-plough system on sloping terrain was limited to computer simulation of static mathematical models. It is recommended that the computer simulation of dynamic mathematical models be also studied to develop a dynamic stability criterion for selection of optimum tractor-plough systems. This will lead to selection of more stable and least-cost tractor-plough systems.

- (iii) In the present study a series of field tests were conducted to determine some soil physical properties and performance factors of a tractor–plough system. Manual measurements of field performance parameters were drudgery and time consuming. However, this can be partly solved, in future studies, by the use of computerized data acquisition system which will reduce drudgery and improve the results quality.
- (iv) The developed model used plough fixed cost, repair and maintenance cost, labour charge, oil cost, fuel cost and tractor operating cost to determine the total annual costs of tractor and plough combinations. Other annual cost components like timeliness costs and probabilities of working days were not included. The developed model can be modified to include these considerations.

REFERENCES

- Abbaspour-Gilandeh, Y., Omid, M. and Keyhani, A. (2007). Simulation Program for Predicting Tractor Field Performance. *World Applied Sciences Journal* 2(5):552-558.
- Abubakar, M. S., Ahmad, D. and Akande, F. B. (2010). A Review of Farm Tractor Overturning Accidents and Safety. *Pertanika Science and Technology Journal* 18 (2): 377 – 385.
- Abu-Hamdeh, N. H. and Al-Jalil, H. F. (2004). Computer Simulation of Stability and Control of Tractor-Trailed Implement Combinations under Different Operating Conditions. *Bragantia Camp* 63 (1): 149-162.
- Ahmadi, I. (2011). Dynamics of Tractor Lateral Overturn on Slopes under the Influence of Position Disturbance. *Journal of Terramechanics* 48: 339-346.
- Al-Hamed, S. A. and Al-Janobi, A. (2000). A Program for Predicting Tractor Performance in Visual C++. *Elsevier Computers and Electronics in Agriculture. Elsevier Science B.V.*
- Al-Hamed, S. A. and Al- Janobi, A. (2001). An Object-Oriented Program to Predict Tractor and Machine System Performance. In: *Research Bulletin No (106). King Saudia University.*

- Al-Hamed, S. A., Grisso, R. D., Zoz, F. M. and Von Bargen, K. (1990). Tractor Performance Spreadsheet for Radial Tyres. In: *Meeting Presentation. Sponsored by the American Society Agricultural Engineers (ASAE)*.
- Andrade, P. and Jenkins, B. (2003). Identification of Patterns of Farm Equipment Utilization in two Agricultural Regions of Central and Northern Mexico Agricultural Engineering International. *The CIGR Journal of Scientific Research and Development. Vol. 5*.
- ASABE (2006). ASABE Standard D497.5FEB06: Agricultural Machinery Management Data. St. Joseph MI.
- ASAE (1998). Soil Cone Penetrometer, ASAE Standard: ASAE S313.1St. Joseph, MI, ASAE
- ASAE (2003).ASAE Standards D497.4FEB03: Agricultural Machinery Management Data. St. Joseph, MI, ASAE.
- ASTM (2007). Standard Test Method for Particle-Size Analysis of Soils-ASTM D422 – 63.American Society for Testing Materials, USA
- Atanda, E.O. (2005). Investigation into Different Types of Accidents Experienced by Farm Tractor Operators in Ondo State, Nigeria. In: *Proceedings of the Nigeria Institution of Agricultural Engineers. 27: 87 – 94*.

- Aybek, A. and Boz, I. (2006). The Influence of Various Factors on Tractor Selection. In: *Proceedings of the Agricultural Mechanization in Asia, Africa, and Latin America (AMA) Symposium*. (Edited by Y. Kishida), Farm Machinery Industrial Research Corp. Japan, .37(2):58-61.
- Bakhit, S. A. E., Mohamed H. I. and Eltom, O. M.(2006). An Empirical Simulation Model of Costs of Wheat Combine.*Journal of Science and Technology Vol. 7(1)*.
- Bekker, M. G. (1956). *Theory of Land Locomotion the Mechanics of Vehicle Mobility*. University of Michigan Press.
- Bol, M. B. and Mohamed, H. I. (1997). A Mathematical Algorithm for Farm Machinery Selection. College of Agriculture, Upper Nile University, Khartoum, Sudan.
- Brixius, W. W. (1987). Traction Prediction for Bias-Ply Tyres, ASAE Paper No. 871622 St, Joseph Mich. ASAE, USA.
- Bronson, G. J. and Rosenthal, D. (2005). *Introduction to Programming with Visual. Basic. Net*. Jones and Bartlett Publishers Inc. USA.
- Camarena, E. A., Gracia, C. and Sixto, J. M. C. (2004). A Mixed Integer Linear Programming of Machinery Selection for Multi-Farm Systems. *Journal Bio-Systems Engineering Vol. 87(2): 145-154*.
- Chaplin, J., Hansen, D. and Fan, T. (1988). Drawbar performance prediction using microcomputer. *NACTA Journal*, Minnesota-ST, Paul.MN 55108 USA.

- Clarke, L. J. (2000). Strategies for agricultural mechanization development: The role of the private sector and the government. *Agricultural Engineering International, CIGR Ejournal* vol. II.
- Dash, R. C. and Sirohi, N. P. S. (2008). A Computer Model to Select Size of Farm Power and Machinery for Paddy-Wheat Rotation in Northern India. *Agricultural Engineering International: the CIGR E Journal*. Manuscript PM 08 012. Vol. X.
- Datt, P. (1988). A Successful Model for Introducing Agricultural Machinery. *Agricultural Mechanization in Asia, Africa and Latin America AMA*, 19 (2): PP: 72 – 76.
- De Pauw, E. F. (1984). Soils and Physiographic and Agro ecological Zones of Tanzania. Monitoring and Early Warning Systems Publication, FAO/Ministry of Agriculture.
- Demsar, I., Bernik, R., and Duhovnil, J. (2012). A Mathematical Model and Numerical Simulation of the Static Stability of a Tractor. *Agriculturae Conspectus Sientificus*. 77(3): 143-150.
- Dwyer, M. J., Evernden, D. W. and McAllister, M. (1976). Handbook of agricultural tyre performance. *Report No18, National Institute of Agricultural Engineering, Silsoe, UK*.
- Edwards, W. (2002). Farm Machinery Selection. IOWA State University - University Extension file A3-23.

- FAO (2010). *Agricultural Mechanization in Mali and Ghana: Strategies, Experiences and Lessons for Sustained Impacts*. Food and Agriculture Organization of the United Nations Rome.
- FAO/UNIDO (2008). *Agricultural Mechanization in Africa- Time for Action. Planning Investment for Enhanced Agricultural Productivity. Report of an Expert Group Meeting, Viena Austria.*
- FAO/UNIDO (2010). *Investment in Agricultural Mechanization in Africa. In: Proceedings of Round Table Meeting of Experts, Arusha, Tanzania.*
- Fagnoli, M., Laurendi, V. and Tronci, M. (2010). *A Risk Assessment Procedure for the Users of Narrow Track Tractors. In: Proceedings of the 2nd Ragusa SHWA Int. Conference. Ragusa, Italy.*
- Franklin, S. and Walker, C. (2010). *Survey Methods and Practices*. Published by the Authority of the Minister Responsible for Statistics Canada. Ministry of Industry.
- Gao Qiong, Pitt, R. E. and Ruina, A. A. (1986) .*Model to Predict Soil Forces on the Plough Mouldboard. Journal of Agricultural Engineering Research, 35:141-155.*
- Gee-Clough, D., McAllister, M., Pearson, G. and Evernden, D. W. (1978). *The Empirical Prediction of Tractor - Implements Field Performance. Journal of Terramechanics 15 (2), 81 - 94.*

- Gilfillan, G. (1978). Polar Diagram Representation of Tractor Stability and Control on Slope Scottish Institute of Agricultural Engineering, *Technical Report*, SIAE, Bush Estate, Penicuik, Midlothian EH26 OPH.
- Grisso, R. D., Al.Hamed, S. A., Taylor, R. K. and Zoz, F. M. (1992). Demonstrating Tractor Performance Trends Using Lotus Template. *Applied engineering in agriculture*, November 1992, Chicago Illinois, 8(6): 733 – 738.
- Grisso, R. D., Perumpral, J. V. and Zoz, F. M. (2006). Spread Sheet for Matching Tractors and Drawn Implements. *Applied Engineering of Agriculture*, 23(3): 259 - 265.
- Harrigan, T. M. and Rotz, C. A. (1994). Draft of Major Tillage and Seeding Equipment. ASAE Paper No. 94-1533, St. Joseph, Mich.: ASAE.
- Harshman, W. C., Yoder, A. M., Hilton, J. W. and Murphy, D. J. (2004). Tractor Stability. The Pennsylvania State University, National safe tractor & machinery operation program. Agricultural and Biological Engineering Dept.246 Agricultural Engineering building. University Park, PA 16802.
- Hunt, D. (1983). Farm Power and Machinery Management. Iowa State University Press, Ames.
- Hunter, A. G. M. and Owen, G. M. (1985). Tractor Overturning Accidents on Slopes. *Journal of Occupational Accidents*, Elsevier Source Publishers B.V. Amsterdam. 5, 195–210.

- Kasterns, T. (1997). Farm Machinery Operation Cost Calculations. Kansas State University Agricultural Experiment Station and Cooperative Extension Service.
- Kothari, G. R. (2004). *Research Methodology: Methods and Techniques*. (2nd Edition), New Age International (P) Ltd Publishers. New Delhi. India.
- Kuczewski, J. (1981). Soil Parameters for Predicting the Draught of Model Plough Bodies. *Journal of Agricultural Engineering Research*, 1981, 261 141-155.
- Kumar, G. V. P. and Dewangan, K. N.(2009). Agricultural Accidents in North Eastern Region of India. *Safety Science*, Issue 47(2):199-205.
- Lairenjam, C. (2003). Agricultural Mechanization, Krishi Vigyan Kendra in Phek District. The Indian Council of Agricultural Research (ICAR).
- Landau, S. and Everitt, B. S. (2004). *A Handbook of Statistical Analyses using SPSS*. CHAPMAN & HALL/CRC A CRC Press Company Boca Raton London New York Washington, D.C.
- Larson, L. W., Lovely, W. G. and Bockhop, C. W. (1968). Predicting Draught Forces Using Model Mouldboard Ploughs in Agricultural Soils. *Transactions of the American Society of Agricultural Engineering*. 11(5): 665-668.
- Law, A. M. and McComas, M. G. (2001). Simulation Principles. In: *Proceedings of the Simulation Conference*. (Edited by Peter, B. D et al.), 7-9 July 2001, New York, USA. pp. 125-132.

- Liljedahl, J. B., Turnquist, P. K., Smith, D. W. and Hoki, M. (1997). *Tractors and Their Power Units*. CBS Publishers and Distributors, New Dhelhi, India.
- Macmillan, R. H. (2002). *The Mechanics of Tractor-Implement Performance*. International Development Technologies Centre. University of Melbourne, Australia.
- MAFC (2008). *Assessment and Establishment of Database of Field Performance and Farm Power Requirement in Seven Agro-Ecological Zones*. Project No 11: CO8D03. Ministry of Agriculture, Food Security and Co-operatives.
- Masawe, J. L. (1994). *Agricultural Credit as an Instrument of Rural Development in Tanzania. - A Case Study on the Credit Program for Tractorization of Small Scale Agriculture in Morogoro Region*. African study monographs 15(4) 211-226. Kyoto university department of agricultural and forestry economics.
- MDC (2009). *Annual Socio-economic Development Report*. Mvomero District Council, Morogoro.
- Miyazaki, M. (2001). *Mechanized Farming For Slopeland Orchards*. Shikoku National Agricultural Experiment Station. Japan.
- Mlingano ARI (2006). *A Map of Morogoro and Mvomero Agro-Ecological Zone*. Ministry Agriculture, Food Security and Co-operatives, Tanzania.

MOVEK Development Solution Ltd (2008). *Small Farmer Productivity through Increased Access to Draught Power Opportunities: Stakeholder mapping*. Dar es Salaam, Tanzania.

Mpanduji, S. M., Dihenga, H. O., Mganilwa, Z. M., Makungu, P. J. and Salim, B. A. (2004). Annual Costs of Using Traction in Tanzania - The Role of Engineering and Technology in Poverty Reduction. In: *Proceedings of Tanzania Society of Agricultural Engineers Vol. 9* (Edited by Tumbo, S. D., Mganilwa, Z. M., Salim, B. A. and Mpanduji, S. M.). Dar es Salaam, Tanzania. pp. 116-121.

Naderi, M., Alimardani, R., Abbaszadeh, R. and Ahmadi, H. (2008). Assessments of Dynamic Load Equations through Drive Wheel Slip Measurement. *American - Eurasian Journal of Agriculture & Environmental Science* Vol. 3 (5): 778 - 784, 2008.

Olaoye, J. O. and Rotimi, A. O. (2010). Measurement of Agricultural Mechanization Index and Analysis of Agricultural Productivity of some Farm Settlements in South West, Nigeria. *Agricultural Engineering International: the CIGR Ejournal*. Manuscript 1372. Vol XII.

Olatunji, O. M., Burbai, W. and Davies, R. M. (2009). Effect of Weight and Draught on the Performance of Disc Plough on Sandy Loam Soil. *Electronic journal of Environmental, Agricultural and food chemistry*. 8(7): Nigeria.

- Osborn, J. E. and Barrick, W. C. (1970). Systems Analysis Approach to Selection of Farm Equipment. *Southern journal of agricultural economics*. Texas Tech University, USA.
- Oskoui, K. E. and Witney, B. D (1982). The Determination of Plough Draught – Part I Prediction from Soil and Meteorological Data with Cone Index and the Soil Strength Parameter. *Journal of Terramechanics*, 19(2) 97- 106.
- Parkhill, G. J. (1986). A Computer Simulation of Tractor Performance. Proceedings of the Conference on Agricultural Engineering, Adelaide, Institution of Engineers, Australia.
- Raheman, H. (2008). Suitable Tyre Size Selection for 2WD Tractor. *The Institute of Engineers (India) Journal Volume 89*.
- Rasouli, F. J., Sadighi, H. and Minai, S. (2009). Factors affecting agricultural mechanization: A case study on sunflower seed. *Journal of Agricultural Science & Technology*, 2: 39 – 48.
- Reece, A. R. (1966). Principles of soil - vehicle mechanics. *Proceedings of Institution of Mechanical Engineers*, 180 Part2A, 125-31.
- Rondelli, V., Martelli, R.; Casazza, C. and Guarnieri, P. (2013). A Methodological Approach to Assess Tractor Stability in Normal Operation in Field Using a Commercial Warning Device. *Journal of Agricultural Engineering*, Volume XLIV (s2)132, Italy.

- Rotz, C. A., Muhtar, H. A. and Black, J. R. (1983). A Multiple Crop Machinery Selection Algorithm. *ASAE*, 26 (6): 1644-1649.
- Runyan, J. L. (1993). A Review of Farm Accidents Data Sources and Research: Review of Recently Published and Current Research. Bibliographies and Literature of Agriculture No. 125. Series of US Department of Agriculture. Economic Research Service. 1301. New York Avenue. Washington DC..
- Ryder, W. H. and Voyadgis, D. E. (1996). Measuring the Performance of Algorithms for Generating Ground Slope, USATEC Paper: Presented at DCAC TEM February 1996.
- Schuler, R. T. (2006). Estimating Agricultural Machinery Costs. -Revised Version. University of Wisconsin, UW-Extension, A3510.12 pp
- Sharabiani, V. R. and Ranjbar, I. (2008). Determination of the Degree, Level and Capacity Indices for Agricultural Mechanization in Sarab Region *Journal of Agriculture Science and Technology Vol. 10: 215-223*.
- Shetto, R. M. (2004). Status of Agricultural Mechanization in Tanzania and the Way Forward - The role of Engineering and Technology in Poverty Reduction. In: *Proceedings of Tanzania Society of Agricultural Engineers vol. 9* (Edited by Tumbo, S. D., Mganilwa, Z. M., Salim, B. A. and Mpanduji, S. M.), pp116-121. Dar es Salaam, Tanzania.

- Siemens, J.C. (1997). Field Machinery Selection Using Simulation and Optimization. In Peart and Curry (eds) *Agricultural Systems Modeling and Simulation*, Marcel Dekker, pp. 543-566.
- Simion, P. And Nastase, S. (2009). *Contributions to the Study of the Dynamics of Agricultural Tractors Equipped with Front-end Loader and Rear Forklift Loader*. Engineering For Rural Development Jelgava.
- Singh, G. (2006). Estimation of a Mechanization Index and Its Impact on Production and Economic Factors - A Case Study in India. *Biosystems Engineering* 93 (1), 99–106.
- Soni, P. and Ou, Y. (2011). *Agricultural Mechanization at Glance in Selected Country Studies in Asia on Agricultural Machinery Development*. APCAEM –ESCAP.
- Spencer, H. B. (1978). Stability and Control of Two-Wheel Drive Tractors and Machinery on Sloping Ground. *Journal of Agricultural Engineering Research* 23: 169-188.
- Spencer H. B., Owen G. M. (1981). A Device for Assessing the Safe Descent Slope of Agricultural Vehicles, *Journal of Agricultural Engineering Research* 26:277-86.
- SPSS V.11.5 (2002). *Statistical Package for Social Science*. SPSS Inc. 233 South Wacker Drive, 11th Floor, Chicago.
- Summer, P. E. and Williams, E. J. (2007). *What Size of Farm Tractor Do I Need?* University of Georgia Mis. Pub. No. Eng. 07 - 003. College of Agriculture.

- Taylor, R., Shrock, M. and Wertz, K. (1991). *Getting the Most From Your Tractor*.
[<http://www.oznet.ksu.edu/library/ageng2/mf588.pdf>] site visited on 24/10/2009.
- Tilakaratna, H. M. (2003). *Agricultural Mechanization Status in Sri-Lanka. Proceedings of UNAPCAEM Technical Advisory Meeting, Hanoi, Vietnam, 13-14 December, 2003.*
- Tilakaratna, H. M (2005). *Mechanization Status in Sri-Lanka. Proceedings of UNAPCAEM Workshop, New Delhi, India, 2005.*
- Unadi, A. (2012). *The Status of Agricultural Mechanization in Indonesia. Proceedings of UNAPCAEM. Regional Round Table Meeting on Developing Environmentally Sustainable Agricultural Mechanization Strategies (SAMS) for Countries in the Asia – Pacific Region. Bangkok, Thailand, 8-5 December, 2011.*
- UNIDO (2013). *Agricultural Development and Mechanization. A Comparative Survey at a Global Level. United Nations Industrial Development Organization (UNIDO), Vienna, Austria.*
- Upadhyaya, S. K., Williams, T. H., Kemble, L. J. and Collins, N. E. (1984). *Energy Requirement for Chiseling in Coastal Plain Soils. Transactions of the ASAE 27(6):1643-1649.*
- URT (2001). *Agricultural Sector Development Strategy (ASDS). Ministry of Agriculture, Food Security and Cooperatives, Dar es Salaam.*

- URT (2006). *Tanzania Agricultural Mechanization Strategy (TAMS)*. Ministry of Agricultural Food Security and Cooperatives
- Vatsa, D. K. and Saraswat, D. C. (2008). Selection of Power Tiller and Matching Equipment Using Computer Program for Mechanizing Hill Agriculture. *Agricultural Engineering International: CIGR E Journal* Manuscript PM 07 025 Vol. X. February, 2998.
- Vatsa, D. K., Mann, S. S. and Singh, S. P (2009). Mechanization Scenario and Energy Use Pattern of Kangra District. *Journal of Institute of Engineers* Pradesh, India, Volume 90, June 2009.
- White, W. M. (1993). *Soil Sampling and Methods of Analysis*. Canadian Soil Science, Lewis Publishers, pp. 433-662.
- William, E. (2002). *Farm Machinery Selection*, I OWA State University, USA.
- Williams, B. K., Sawyer, S. C., Hutchinson, S. E. (1995). *Using Information Technology. A Practical Introduction to Computers and Communications*. Richard, D. Irwin Inc., USA.
- Wisner, R. D. and Luth H. J. (1972). Off-Road Traction Prediction of Wheeled Vehicles, ASAE Paper No. 72-619.
- Wisner, R. D., Luth, H. J. (1973). Off-Road Traction Prediction for Wheeled Vehicles. *Journal of Terramechanics*, 10: 49–61.

- Wismer, R. D. and Luth H. J. (1974). *Off-Road Traction Prediction for Wheeled Vehicles*
Transactions of American Support Service Project MTF/URT/OD1/MS (phase 1)
Field Document.
- Wong, J. Y. (1993). *Theory of Ground Vehicles*; (2nd Edition), John Wiley & Sons Inc.
New York.
- Yisa, M. G. and Terao, H. (1995). Dynamics of Tractor-Implement Combinations on
Slopes (Part I) -State-of-the-Art-Review-, *Journal of the Faculty of Agriculture*,
Hokkaido University, Vol. 66. Pt. 2, 240-262.
- Yisa, M. G., Terao, H.; Noguchi, N. and Kubota, M. (1997). Dynamics of Tractor-
Implement Combinations on Slopes (Part III) -Stability Regions and Optimum
Design Parameters-, *Journal of the Faculty of Agriculture*, Hokkaido University,
68(1), 1-16.
- Yu, T. (2006). The traction performance of friction - based prototype track Thesis for
Award of PhD Degree at University of Pretoria, South Africa.
- Zoz, F. M. and Grisso, R. D. (2003). *Traction and Tractor Performance*, ASAE
Publication No.913C0403 ASAE 2960 Nilus Rd St. Joseph MI 49085-9659 USA.

APPENDICES

Appendix 1: Test plot No. 1- Wami Luhindo

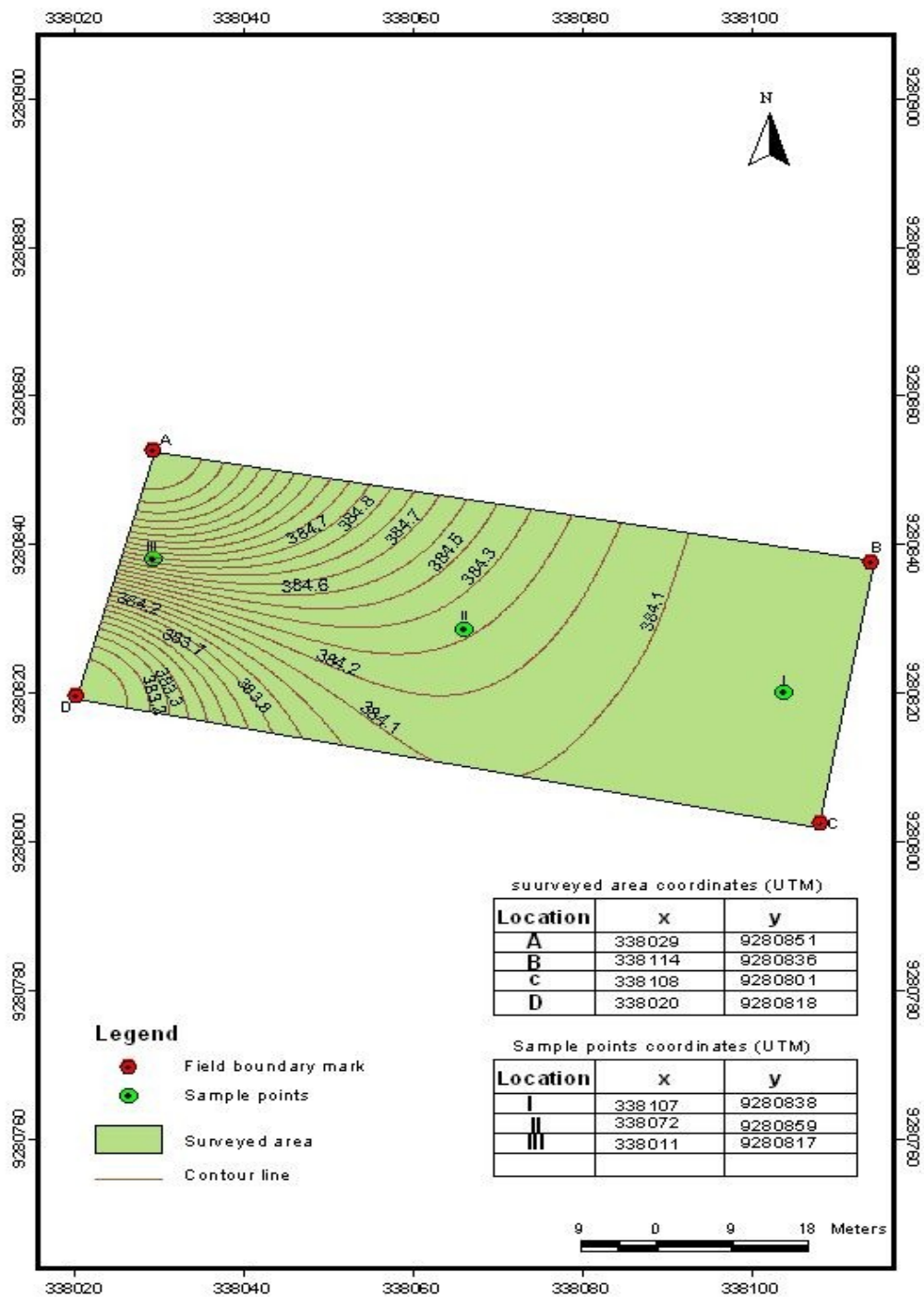

Appendix 2: Test plot No.2- Dakawa Mnadani

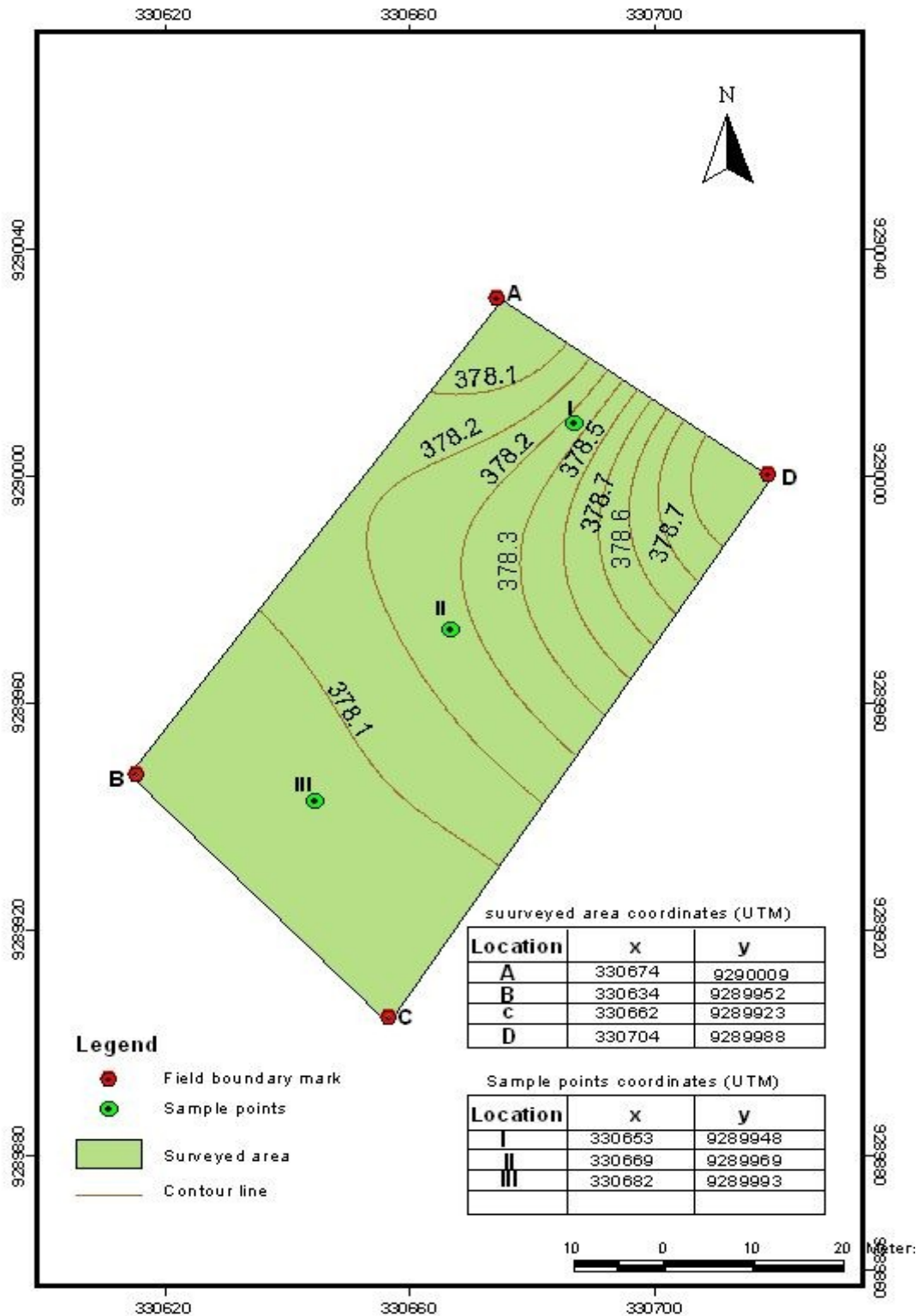

Appendix 3: Test plot No.3- Milama

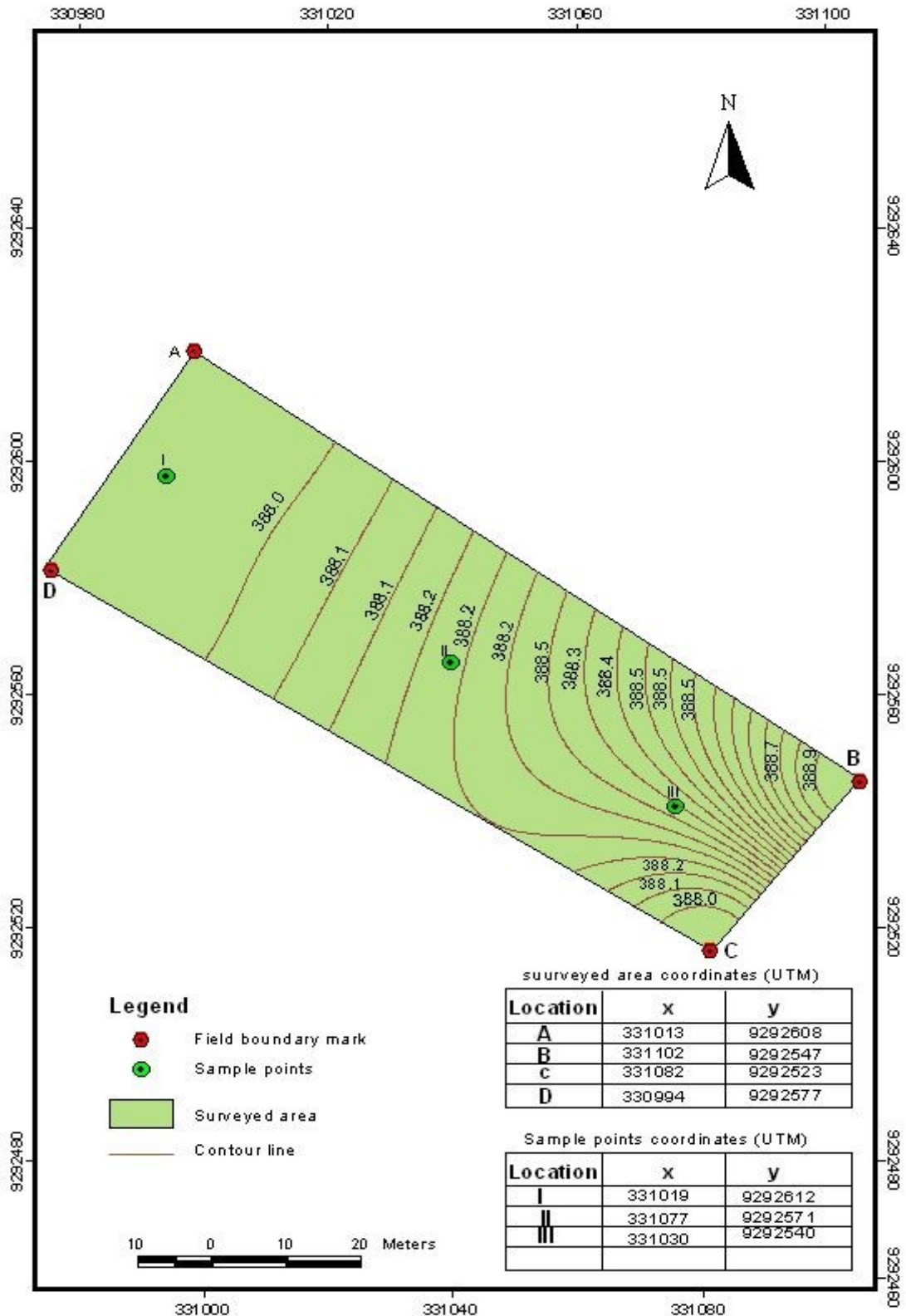

Appendix 4: Test plot No. 4-Mvomero I

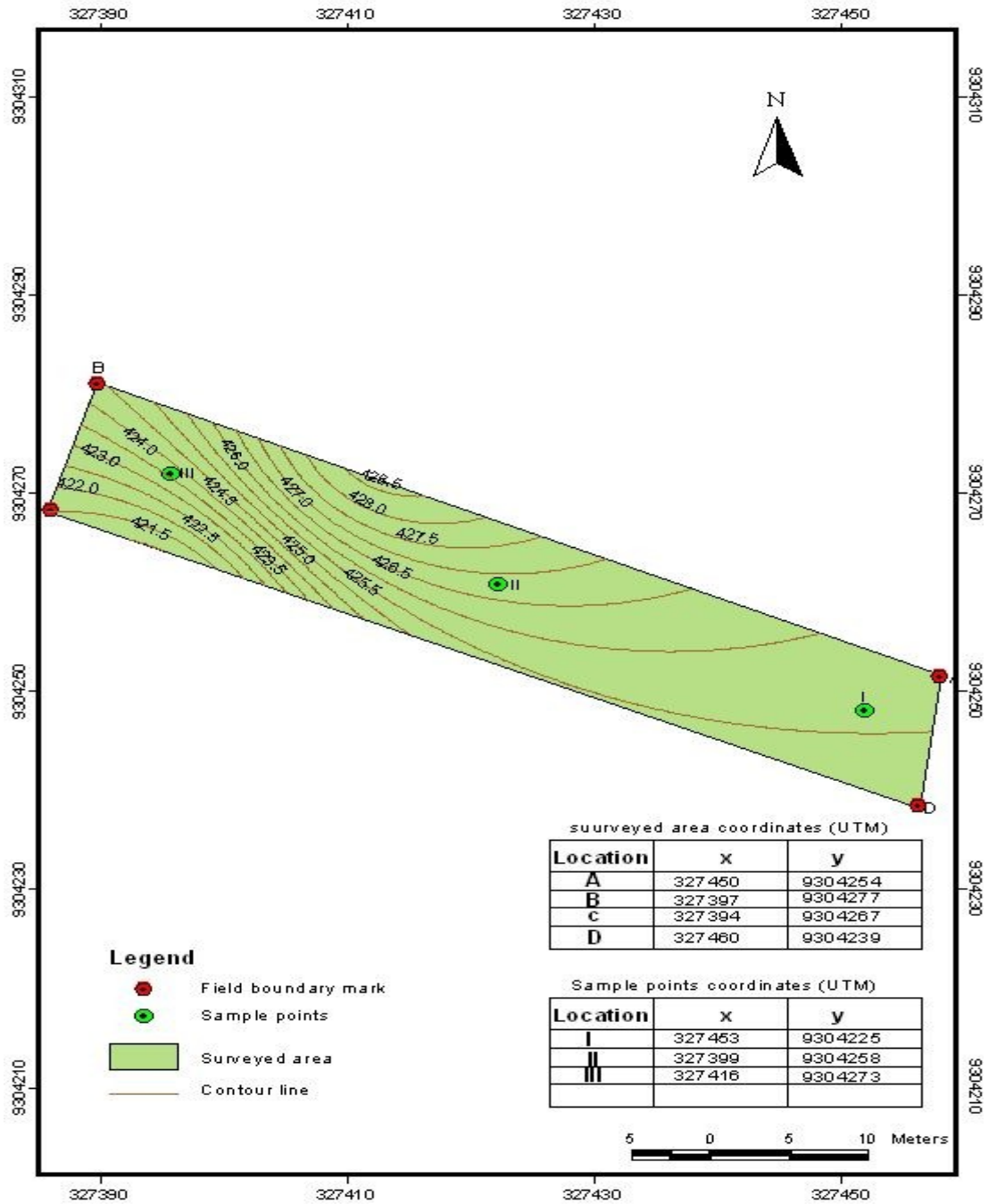

Appendix 5: Test plot No. 5- Mvomero II

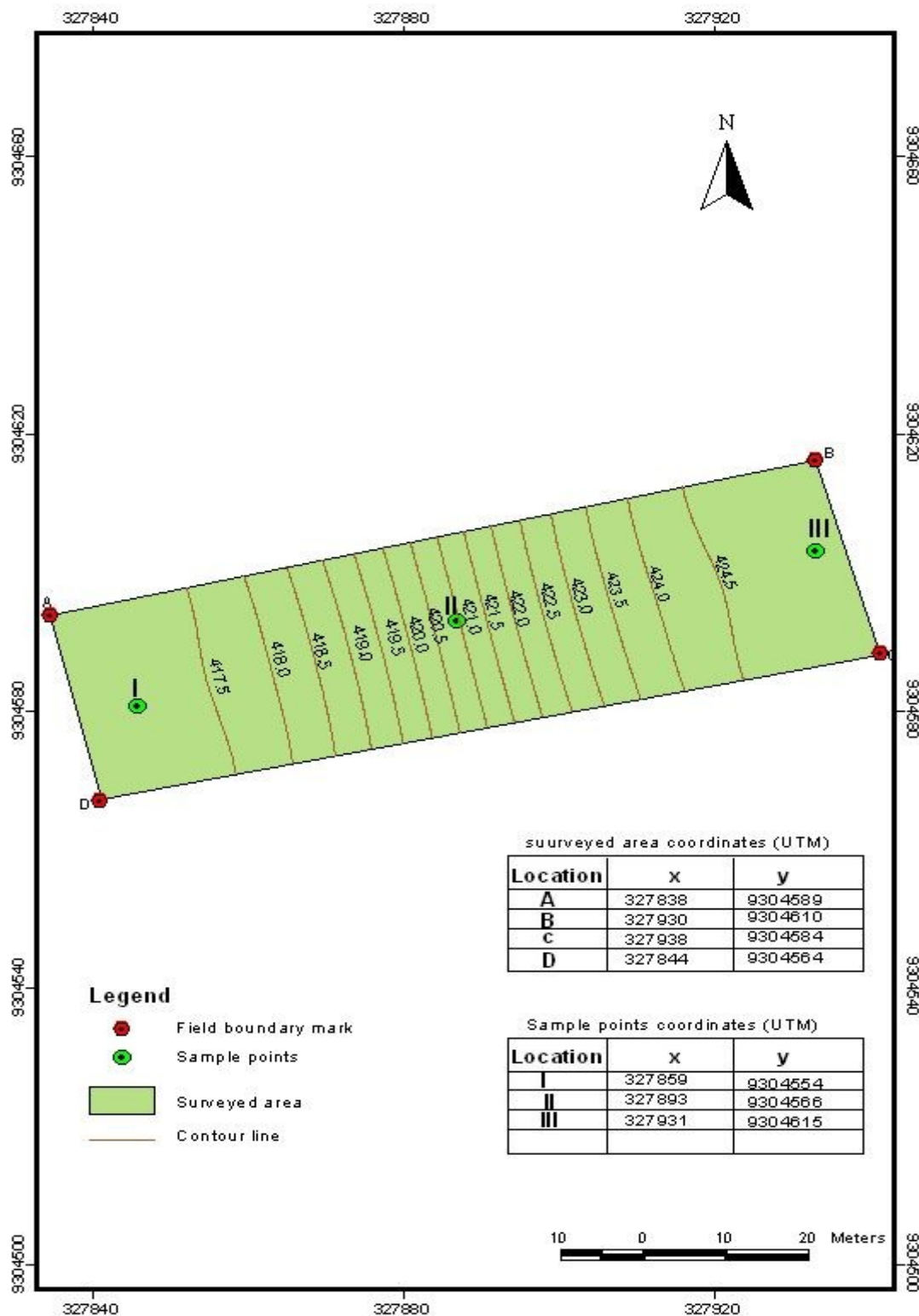

Appendix 6: Test plot No. 6-Mvomero III

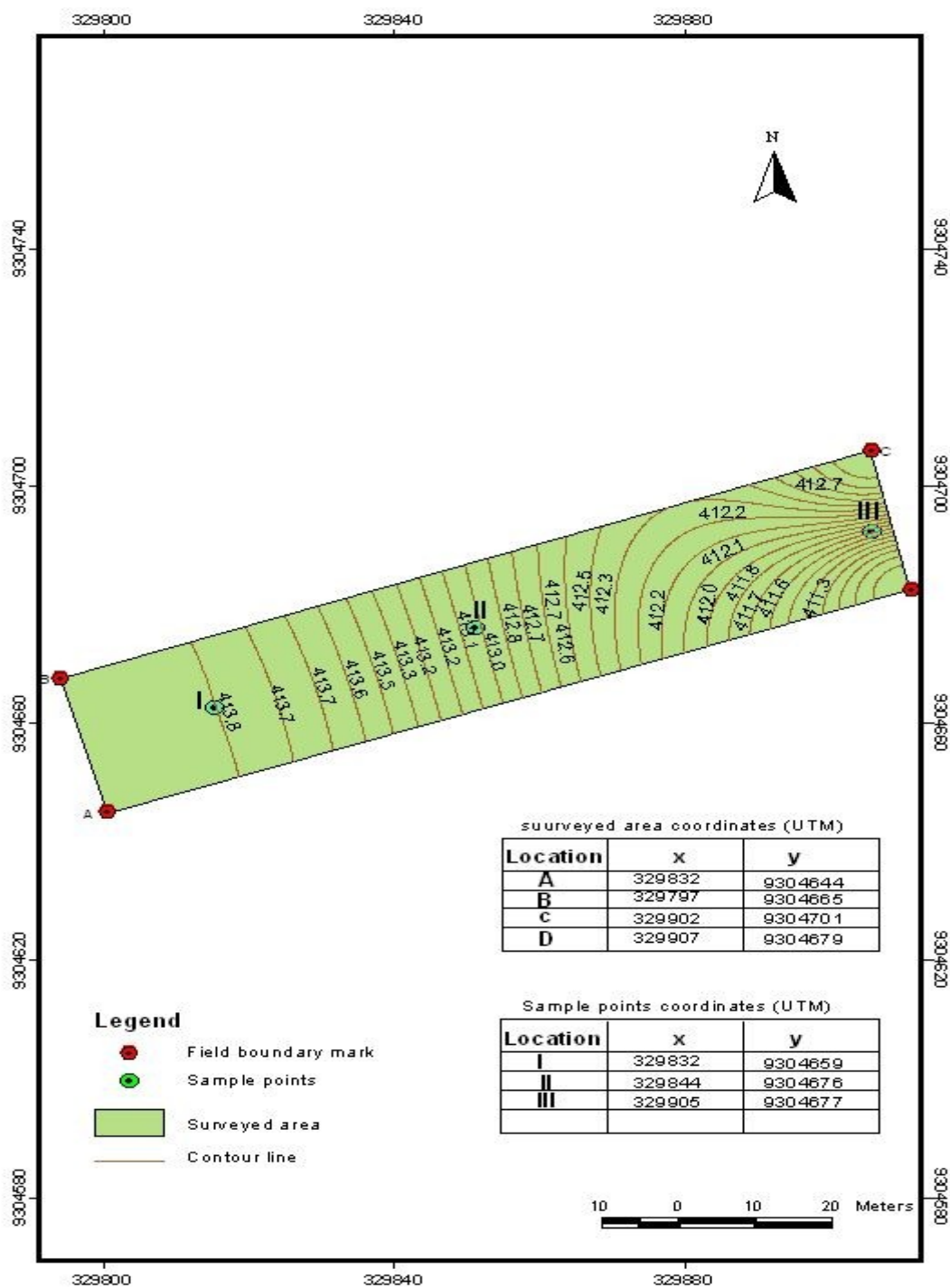

Appendix 7: Test plot No. 7- Hembeti

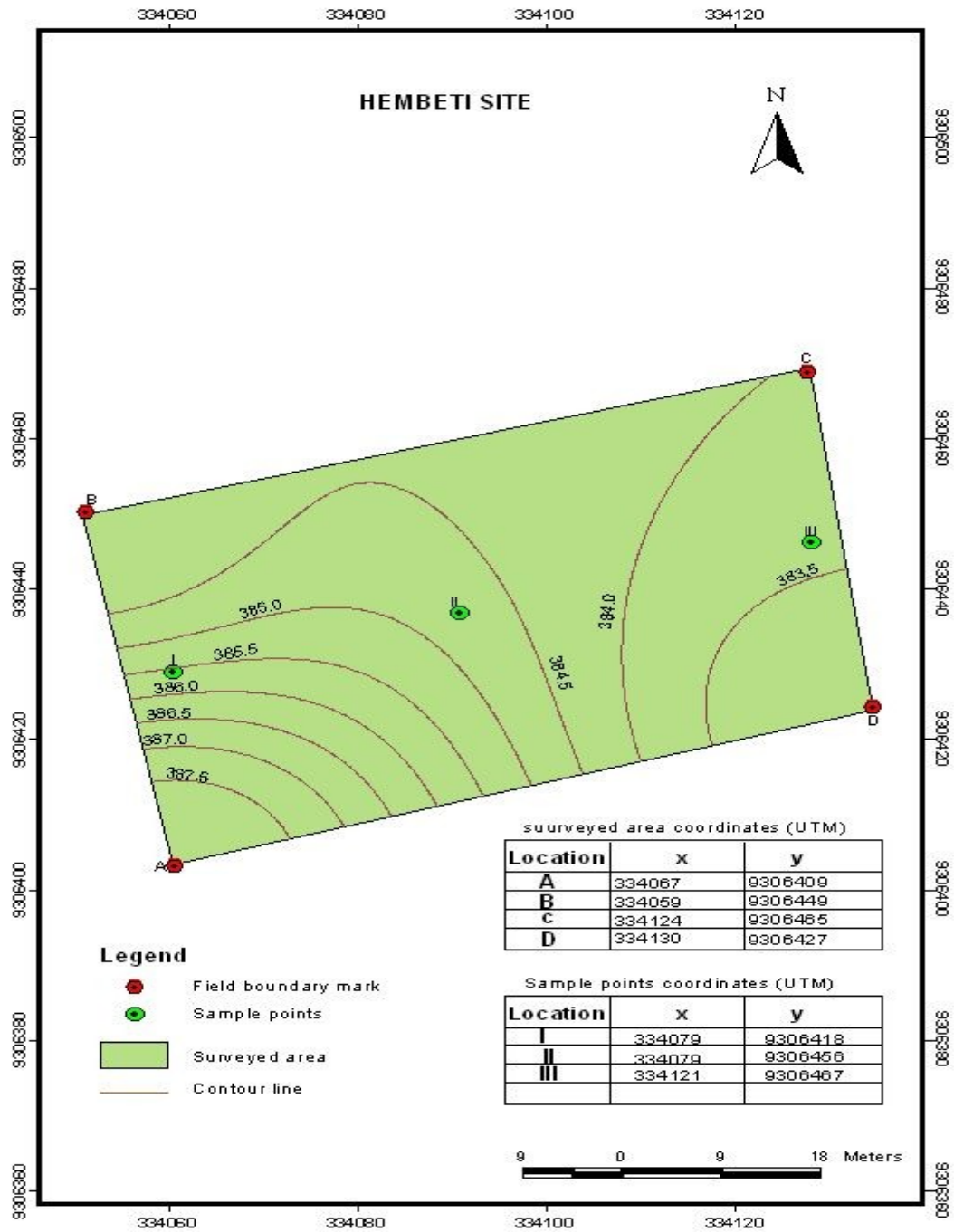

Appendix 8: Test plot No. 8 –Mkindo

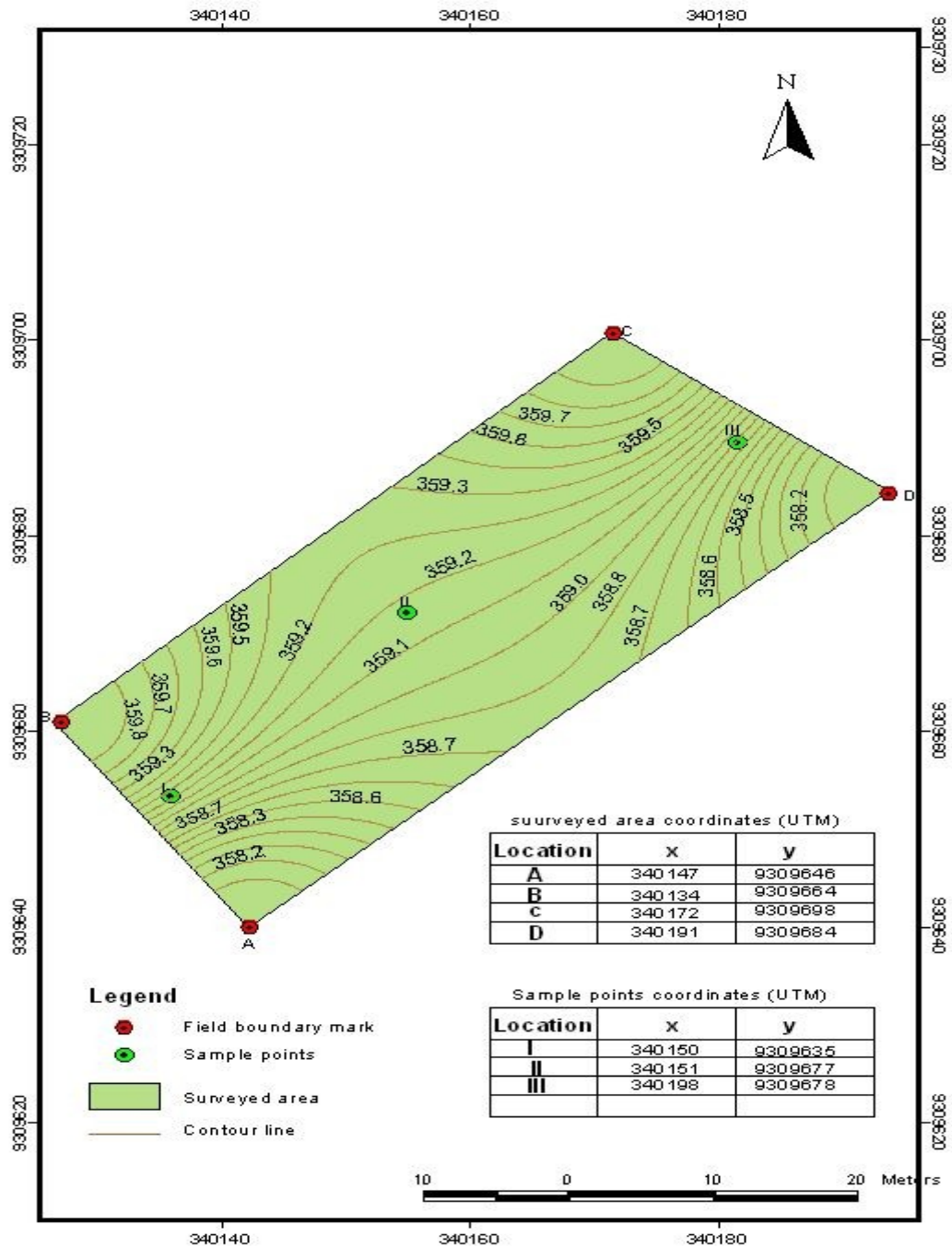

Appendix 9: Table of input data and predicted field performance

INPUT DATA							PREDICTED PERFORMANCE PARAMETERS									
Set No.	Plough ID No.	Tractor ID No.	PTO Power [kW]	Depth of cut [cm]	Width of cut [m]	Speed [km/h]	Draft force [kN]	D.bar pull [k N]	Tilled Area [Ha]	Field capty [Ha/hr]	Fuel [L/hr]	Fuel [L/ha]	Total Fuel [Lit.]	Tractor weight [Kg]	Total cost [TZS]	Grand Total cost [TZS]
1	21	14	74	30	1.25	8	26	32	64	1.0	16.5	16.5	1056	6976	3665720	5330913
	2	16	80	30	1.5	8	26	32	36	0.79	6.9	8.7	313.6	2218	1665193	
2	5	11	179	30	2.54	8	52	53	100	2.0	39.9	20.0	1963.6	15082	6253698	6253698
	4	8	124	25	1.65	8	29	47	84.48	1.32	27.7	21.0	1772.8	11016	6317154	
3	10	19	34	18	0.45	8	6	12	15.52	0.36	7.6	21.1	327.6	2234	1269882	7587036
	22	9	141	30	1.5	8	31	50	76.8	1.2	31.4	26.2	2009.6	12412	6727099	
4	11	17	28	20	0.6	8	8	11	23.3	0.48	6.2	12.9	299.7	2116	1259650	7986749
	9	10	168	30	1.5	8	31	50	76.8	1.2	34.8	29.0	2227.2	13660	8128784	
5	12	1	36	25	0.75	8	13	13	23.2	0.6	7.8	13.0	301.6	2531	1651038	9779822
	15	7	308	30	1.5	8	31	65	76.8	1.2	68.7	57.3	4396.8	12892	16717313	
6	16	20	34	25	0.6	8	10	11	23.2	0.48	7.6	15.8	367.3	2130	1446315	18163628

Appendix 10: Table of simulation results* (labour cost increased by TZS 1 000)

TRACTOR	PLOUGH	OPERATING SPEED	AREA	TOTAL COST
N. Holland/TV6070/14	Aeco/1LY(T)_525/21	8	64	
John Deere/5103/16	Alvan Blanch/ADP3/2	8	36	
TOTALS TO			100	5440368
N. Holland/TG305/11	Aeco/1LY(SX)320/5	8	100	
TOTALS TO			100	6302911
N. Holland/TG215/8	Alvan Blanch/ADP5/4	8	84.48	
John Deere/5203/19	Aeco/1LQ_315/10	8	15.52	
TOTALS TO			100	7694147
N. Holland/TG245/9	Aeco/1LY(T)_625/22	8	76.8	
John Deere/5105/17	Aeco/1LQ_320/11	8	23.2	
TOTALS TO			100	8099082
N. Holland/TG275/10	Aeco/1LY(SX)625/9	8	76.8	
M.Ferguson/451/1	Aeco/1LQ_325/12	8	23.2	
TOTALS TO			100	9882488
N. Holland/T9050/7	Aeco/1LQ_530/15	8	76.8	
John Deere/5205/20	Aeco/1LYX_230/16	8	23.2	
TOTALS TO			100	18275961

*Input data:

- (i) Total area = 100 ha
- (ii) Allotted time = 8 days
- (iii) Average working hours per day = 8 hours
- (iv). Operating speed = 8 km/h
- (v) Operating depth and width of cut = depended on the matched plough
- (vi) Labour cost = 6000/- per hectare
- (vii) Fuel cost per litre = 2000/-
- (viii) Cone Index = 1200 k Pa

Appendix 11: Table of simulation results* (labour cost increased by TZS 2 000)

TRACTOR	PLOUGH	OPERATING SPEED	AREA	TOTAL COST
N. Holland/TV6070/14	Aeco/1LY(T)_525/21	8	64	
John Deere/5103/16	Alvan Blanch/ADP3/2	8	36	
TOTALS TO	...		100	5549822
N. Holland/TG305/11	Aeco/1LY(SX)320/5	8	100	
TOTALS TO	...		100	6352124
N. Holland/TG215/8	Alvan Blanch/ADP5/4	8	84.48	
John Deere/5203/19	Aeco/1LQ_315/10	8	15.52	
TOTALS TO	...		100	7801258
N. Holland/TG245/9	Aeco/1LY(T)_625/22	8	76.8	
John Deere/5105/17	Aeco/1LQ_320/11	8	23.2	
TOTALS TO	...		100	8211415
N. Holland/TG275/10	Aeco/1LY(SX)625/9	8	76.8	
M.Ferguson/451/1	Aeco/1LQ_325/12	8	23.2	
TOTALS TO	...		100	9985155
N. Holland/T9050/7	Aeco/1LQ_530/15	8	76.8	
John Deere/5205/20	Aeco/1LYX_230/16	8	23.2	
TOTALS TO	...		100	18388295

***Input Data**

- (i) Total area = 100 ha
- (ii) Allotted time = 8 days
- (iii) Average working hours per day = 8 hours
- (iv) Operating speed = 8 km/h
- (v) Depth and width of cut = depended on the matched plough
- (vi) Labour cost = 7000/- per hectare
- (vii) Fuel cost per litre = 2000/-
- (viii) Cone Index = 1200 k Pa

Appendix 12: Simulation results* (Fuel cost increased by TZS 500)

TRACTOR	PLOUGH	OPERATING SPEED	AREA	TOTAL COST
N. Holland/TV6070/14	Aeco/1LY(T)_525/21	8	64	
John Deere/5103/16	Alvan Blanch/ADP3/2	8	36	
TOTALS TO			100	6118454
N. Holland/TG305/11	Aeco/1LY(SX)320/5	8	100	
TOTALS TO			100	7382758
N. Holland/TG215/8	Alvan Blanch/ADP5/4	8	84.48	
John Deere/5203/19	Aeco/1LQ_315/10	8	15.52	
TOTALS TO			100	8794791
N. Holland/TG245/9	Aeco/1LY(T)_625/22	8	76.8	
John Deere/5105/17	Aeco/1LQ_320/11	8	23.2	
TOTALS TO			100	9314577
N. Holland/TG275/10	Aeco/1LY(SX)625/9	8	76.8	
M.Ferguson/451/1	Aeco/1LQ_325/12	8	23.2	
TOTALS TO			100	11233882
N. Holland/T9050/7	Aeco/1LQ_530/15	8	76.8	
John Deere/5205/20	Aeco/1LYX_230/16	8	23.2	
TOTALS TO			100	20903005

***Input Data**

- (i) Total area = 100 ha
- (ii) Allotted time = 8 days
- (iii) Working hours per day = 8 hours
- (iv) Operating speed = 8 km/h
- (v) Depth and width of cut = depended on the matched plough
- (vi) Labour cost = 5000/- per hectare
- (vii) Fuel cost per litre = 2500/-
- (viii) Cone Index = 1200 k Pa

Appendix 13: Simulation results* (Draught requirement increased by 20%)

TRACTOR	PLOUGH	OPERATING SPEED	AREA	TOTAL COST
N. Holland/TV6070/14	Aeco/1LY(T)_525/21	8	64	
John Deere/5103/16	Alvan Blanch/ADP3/2	8	36	
TOTALS TO		100	7693536
N. Holland/TG305/11	Aeco/1LY(SX)320/5	8	100	
TOTALS TO		100	9640878
N. Holland/TG215/8	Alvan Blanch/ADP5/4	8	84.48	
John Deere/5203/19	Aeco/1LQ_315/10	8	15.52	
TOTALS TO		100	11210302
N. Holland/TG245/9	Aeco/1LY(T)_625/22	8	76.8	
John Deere/5105/17	Aeco/1LQ_320/11	8	23.2	
TOTALS TO		100	11970234
N. Holland/TG275/10	Aeco/1LY(SX)625/9	8	76.8	
M.Ferguson/451/1	Aeco/1LQ_325/12	8	23.2	
TOTALS TO		100	14142002
N. Holland/T9050/7	Aeco/1LQ_530/15	8	76.8	
John Deere/5205/20	Aeco/1LYX_230/16	8	23.2	
TOTALS TO		100	26381758

***Input Data**

- (i) Total area = 100 ha
- (ii) Allotted time = 8 days
- (iii) Working hours per day = 8 hours
- (iv) Operating speed = 8 km/h
- (v) Depth and width of cut = depended on the matched plough
- (vi) Labour cost = 5000/- per hectare
- (vii) Draught requirement = increased by 20%
- (viii) Cone Index = 1200 k Pa

Appendix 14: Table of simulation results* (Draught reduced by 20%)

TRACTOR	PLOUGH	OPERATING SPEED	AREA	TOTAL COST
M.Ferguson/4260/5	Aeco/1LY(SX)525/8	8	64	
Farmtrac/675DTC/15	Aeco/1LQ_426/13	8	36	
TOTALS TO	...		100	4959195
N. Holland/TG215/8	Aeco/1LY(SX)320/5	8	100	
TOTALS TO	...		100	4979131
John Deere/5105M/...	Aeco/1LQ_525/14	8	64	
N. Holland/TN95DA/...	Aeco/1LY(T)_425/20	8	36	
TOTALS TO	...		100	5127014
N. Holland/TV6070/14	Aeco/1LY(T)_525/21	8	64	
M.Ferguson/451/1	Aeco/1LYX_330/17	8	36	
TOTALS TO	...		100	5589468
M.Ferguson/4370/6	Alvan Blanch/ADP4/3	8	67.5...	
M.Ferguson/481/3	Aeco/1LY(SX)325/6	8	32.4...	
TOTALS TO	...		100	6252543
N. Holland/TG275/10	Alvan Blanch/ADP5/4	8	84.48	
John Deere/5103/16	Aeco/1LQ_325/12	8	15.52	
TOTALS TO	...		100	8198870

***Input Data**

- (i) Total area = 100 ha
- (ii) Allotted time = 8 days
- (iii) Working hours per day = 8 hours
- (iv) Operating speed = 8 km/h
- (v) Depth and width of cut = depended on the matched plough
- (vi) Labour cost = 5000/- per hectare
- (vii) Draught requirement = reduced by 20%
- (viii) Cone Index = 1200 k Pa

Appendix 15: Table of tractors and implements by region

Region	Power tillers	Tractors	Ploughs	Harrowes	Trailers	Planters	Weeders	Sub Soilers	Combine Harvester
Arusha	6	961	912	143	211	52	0	16	38
D'Salaam	1	59	39	24	42	0	0	0	0
Dodoma	26	625	336	4	46	0	0	0	0
Iringa	7	469	306	91	117	14	0	0	0
Kagera	10	97	41	9	9	0	0	0	0
Kigoma	6	31	9	6	11	1	0	0	0
K'njaro	11	861	380	56	339	47	0	0	25
Lindi	6	49	31	6	25	10	0	0	0
Manyara	2	808	619	137	345	49	48	7	0
Mara	6	104	40	0	0	0	0	0	0
Mbeya	90	288	451	131	162	15	0	0	55
Morogoro	24	1156	675	244	50	13	0	0	0
Mtwara	6	32	9	8	7	0	0	0	0
Mwanza	16	256	94	18	118	11	0	0	0
Pwani	7	62	56	34	22	0	0	0	0
Rukwa	5	71	59	27	51	1	0	0	1
Ruvuma	7	161	32	27	23	0	0	0	25
Singida	17	96	47	13	41	0	0	0	0
Shinyanga	3	577	457	23	171	2	0	0	0
Tabora	13	175	35	30	85	11	0	0	0
Tanga	12	272	83	62	142	0	2	0	0
Total	281	7210	4711	1093	2017	226	50	23	144

Source: URT (2006)

Appendix 16: Table of draught animals and implements by region

Region	Oxen	Donkeys	M/Board Plough	Rippers	Harrowes	Planters	Cultivators	Ox-Carts	Donkey Carts	Ridgers
Arusha	16 085	164	13 840	7	0	0	3	2 733	7	0
DSM	7	21	15	1	0	2	4	10		
Dodoma	28 892	3 111	21 362	291	2	4	157	3 994	0	3
Iringa	48 731	7 398	26 299	36	88	20	113	1 571	0	78
Kagera	6 662	60	1 686	0	10	1	19	167	0	27
Kigoma	571	4	125	0	2	0	19	24	0	1
K'njaro	1 314	152	430	19	2	2	51	278	0	153
Lindi	46	9	21	5	4	0	7	12	0	6
Manyara	97 034	40 501	18,355	8,682	26	50	16	3 455	0	2
Mbeya	72,342	1 848	49,553	48	900	35	233	10 401	0	349
Morogoro	3 361	170	1,198	0	0	0	18	603	0	80
Mtwara	48	33	10	0	12	0	5	21	0	10
Mwanza	108 044	238	28 043	32	13	0	24	4 723	0	73
Pwania	248	106	80	3	0	0	0	53	0	0
Rukwa	35 448	3 722	26 477	50	37	10	77	8 183	0	116
Ruvuma	231	138	106	6	21	8	13	69	10	24
Singida	144 336	4 007	64,994	490	14	50	108	15 469	0	44
Shinyanga	421 725	14 935	114,285	0	835	1	389	25 133	0	350
Tabora	114 778	4 997	48,190	0	0	0	40	6 420	0	49
Tanga	746	345	344	19	35	8	106	249	4	46
Mara	207 006	0	169 831	0	0	0	0	2 628	0	0
TOTAL	1 307 655	81 959	585 244	9 689	2001	191	1 402	86 196	21	1 614

Source: URT (2006)

Appendix 17: Table of sources of power for different farm activities among small scale farmers

Power Source	Tillage (%)	Planting (%)	Weeding (%)	Harvesting (%)	Shelling (%)	Transport (%)
Human	29.0	84.5	93.7	98.2	94.5	35.4
Draught animal	43.0	9.3	5.4	1.5	2.9	37.0
Tractor	28.0	6.2	0.9	0.3	2.5	27.6
Total (%)	100.0	100.0	100.0	100.0	100.0	100.0

Source: URT (2006)

Appendix 18: Questionnaire for tractor-owners

Questionnaire number _____

Date _____

Name of interviewer _____

Name of respondent _____

Name of the village _____

Name of ward _____

Name of Division _____

1. Highest level of education attained by tractor-owner (Tick only one)

(a) Not gone to school at all ()

(b) Universal Adult Education ()

(c) Primary school ()

(d) Secondary School ()

(e) Post- secondary /vocational training ()

2. Family size (Adults).....

3. Sex of the tractor-owner: (a) Male () (b) Female () (Tick only one).

4. What is your source of finance for farming operations?

(a) Own funds ()

(b) Informal credit ()

(c) Formal credit ()

5. What are your income generating activities apart from being a farmer? (Tick appropriate)

(a) Farming only ()

(b) Farming and tractor hiring service ()

(c) Farming and tractor hiring service and employed ()

(d) Farming and employed ()

(e) Farming and business ()

6. How big is your farm land? (Ha/acres)

7. How big is your cultivated farm land in the current season (2010/2011)?

.....(Ha/acres)

8. Describe the soil in your area

.....

9. When is the appropriate period for ploughing operation in your area?

(a) From..... to.....

(b) Give the reasons.

.....

10. What is the soil condition during the period of land tillage in the area?

.....

11. Which make(s) of tractor(s) do you own? (Fill all that apply in the table below)

S/N	Make	Model	Power (Hp)	Age	Condition
1.					
2.					
3.					
4.					
5.					
6					
7					

12. What kinds of tractor-operated implement(s) do you own? (Fill all that apply in the table below)

S/N	Make	Model	Max. Capacity	Condition
1.				
2.				
3.				
4.				
5.				
6				
7				

13. What is the work output of your tractor in a day (10 hrs) in ploughing operations?
 (Acres/day)

14. How did you acquire your tractor (s)? (Fill and tick in the appropriate box)

1= Own funds, 2 = dealer credit, 3 = Government loan

S/N	Make of tractor	Model	Power(Hp)	Acquired through:		
				1	2	3
1.						
2.						
3.						
4.						
5.						
6						
7						

15. Which do you think is the most suitable make of tractor in your area?

16. Which do you consider is the most suitable size in terms of hp of tractor in your area?

17. Which do your think is the most suitable type of plough in your area?

18. Which factor did you consider as the first priority in choosing your tractor(s)?

(Tick one).

- (a) Low price ()
- (b) Availability of spare parts ()
- (c) Low fuel consumption ()
- (d) Durability ()
- (e) Power efficiency ()
- (f) Prior experience ()

19. For which operations do you often utilize tractor (s)? (Tick all that apply)

- (a) Ploughing ()
- (b) Harrowing ()
- (c) Sowing and planting ()
- (d) Weeding and chemical spraying ()

- (e) Fertilizer spreading/distributing ()
- (f) Harvesting ()
- (g) Post Harvest operations ()

20. What is the average fuel consumption of your tractor in ploughing operations?

.....Litres/ha

21. What are the average costs for running a tractor per season (Fuel, oils, repair and maintenance/season)?

..... (TZS)

22. Do you provide tractor hiring services to others? (Tick one)

- (a) YES () (b) NO ()

23. If the answer to Q22 above is YES, for which operations do you provide tractor hiring services? (Tick all that apply)

- (a) Primary land tillage ()
- (b) Secondary land tillage ()
- (c) Sowing and planting ()
- (d) Weeding and chemical spraying ()
- (e) Fertilizer spreading/distributing ()
- (f) Harvesting ()
- (g) Post Harvest operations ()

24. How much do farmers pay per acre in the ploughing operation?

.....

25. What problems do you face in hiring services to others?

.....
.....

26. In your opinion what should be the solution to these problems?.....

27. Where is the tractor serviced and why?

28. Are there any local dealers/service providers/local mechanics?

29. Where do you obtain spare parts for your machines?

30. Rank the seriousness of the following constraints with respect to the ownership and use of farm tractors
 (5- most serious, 4- very serious, 3- serious, 2- somewhat serious, 1- least serious, 0- not serious)

SN	Problem						
		5	4	3	2	1	0
1	Difficulties in obtaining spare parts and after sale services						
2	Expensive spare parts						
3	High cost of fuel and lubricants						
4	Lack of well-equipped repair and maintenance service workshops						
5	Scarcity of well-trained tractor mechanics						
6	Scarcity of well-trained tractor operators						
7	Supply of sub- standard tractors						

31. Please give at most four suggestions on how to solve the problems mentioned in Q30

- 1.....
- 2.....
- 3.....
- 4.....

32. In your opinion, what should be done to improve the level of mechanization in your area?

.....
.....
.....

THANK YOU FOR YOUR PARTICIPATION

Appendix 19: Questionnaire for non – mechanized farmer

Questionnaire number
Date
Name of interviewer
Name of respondent
Name of the village Ward

1. Gender Male() Female () (Tick only one)
2. What is your family size?
3. How big is your farm land? (Ha/acres
4. What kind of crops do you grow?
.....
5. Do you hire a tractor? Yes () No () (Tick only one)
6. If yes, for which operations?
.....
.....
7. How much do you pay per acre in the ploughing operation?.....
8. When is the ploughingseason (Date)?
Fromto.....
9. Describe the soil type and behavior in your farm.
.....
.....
10. Does it influence on the timing of the ploughing? Yes () No () (Tick one)
11. What problems do you face relating to the tractor hiring services in your area?
.....
.....
.....
12. In your opinion what should be the solutions to these problems?
.....
.....
.....

THANK YOU FOR YOUR PARTICIPATION

Appendix 20: Questionnaire for extension workers

Questionnaire number
 Date
 Name of interviewer
 Name of respondent
 Name of the village Ward

1. Gender Male () Female () (Tick only one)
2. For how long have you been stationed in this area?.....
3. Describe the status of mechanization in this area?.....
4. What kinds of crops are grown in this area?.....
5. What kinds of farm operations are commonly mechanized in your area?.....
6. How much do farmers pay per acre in the ploughing operation?.....
7. Which kinds of tractor-operated implements are commonly used?.....
8. When is the ploughing season?
 From (Date) to
9. Describe the soil type and behavior (dry/wet) in your area?.....
10. Is the choice of machinery influenced by the soil type? Yes () No ()
 Explain?.....
11. What other factors do farmers consider before purchasing a farm machine?.....
12. In your opinion, what should be done to improve the level of mechanization in your area?.....
13. What do you consider is the most suitable type and size of tractor in your area?
 Why?.....

THANK YOU FOR YOUR PARTICIPATION

Appendix 21: Questionnaire for tractor operators

Questionnaire number Date

Name of interviewer

Name of respondent

Name of the village Ward

1. Gender Male () Female ()(Tick only one)
2. For how long have you been working as an operator?
.....
3. Do you have any formal training in machine operation?
Yes () No () (Tick only one)
3. If the answer to Q.3 is yes, where did you get/receive your training?
.....
4. What was the duration of your training?
.....
5. How do you describe the soil in this area?
.....
6. Does it influence the timing of the ploughing operation?
Yes () No () (Tick only one)
7. If the answer to Q.6 is yes, how it influence?
.....
8. When is the ploughing season? (Date) From To
9. How much do farmers pay per acre in the ploughing operation?
.....
10. What kind of a tractor are you currently operating? (Make and size).....
11. What is the work out put on ploughing operation (acres/day)
.....
12. What is the average fuel consumption of the tractor in ploughing(Litres/acre)
.....
13. What do you consider as the most suited type and size of tractor in your area?
.....
14. Where do you get repairs and maintenance services for the farm tractor? (Tick all that apply)

(a) Home garage	[<input type="checkbox"/>]
(b) Formal garages within the district	[<input type="checkbox"/>]
(c) Formal garages available in the Morogoro Municipality	[<input type="checkbox"/>]
(d) Beyond Morogoro region	[<input type="checkbox"/>]
15. What problems do your face in daily operations?
.....
.....
16. In your opinion what should be the solutions to these problems?
.....

THANK YOU FOR YOUR PARTICIPATION

Appendix 22: Questionnaire for farm machinery dealers/service providers

Questionnaire number

Date

Name of interviewer

Name of respondent

Name of supplier/Dealer -----

Address -----

Tel. ----- Fax ----- E-mail ----- Web

Site-----

1. When was the company established? -----

2. Does your company have branches? Yes [] No [](Tick only one)

3. If yes, List the branches and their physical locations -----

4. Which branches are more active? -----

5. Which types of tractors is your company dealing with? -----

6. Which size of tractor sells better? -----

7. What could be the reasons? -----

8. What are the mechanical problems commonly represented by customers of your tractors?

9. What are the mechanical problems commonly represented by customers of your ploughs? -----

10. Do the soils contribute to the mechanical problems? Yes () No () (Tick only one)

11. If yes, what type of soil? -----

12. What do you consider when recommending on the choice of machinery to clients?

13. Do you offer any type of training to your customers? Yes () No () (Tick only one)

14. If yes, what kind of training?-----

15. Do you provide after sales services to machinery buyers? Yes () No () (Tick only one)

16. Are there any problems associated with supply of agricultural machinery and spares? (Explain) -----

17. Propose solutions to the problems -----

18. In your opinion, what should be done to improve the level of mechanization in Tanzania?

THANK YOU FOR YOUR PARTICIPATION

Appendix 23: Site marking out before field tests



Appendix 24: Progressing with tractor field performance tests



Appendix 25: Counting and timing ten wheel revolutions for wheel slip test



Appendix 26: Close supervision of tractor field performance tests



Appendix 27: Measurement of width and depth of cut



Appendix 28: Tractor – plough system setting before tests



Appendix 29: Measurement of implement draught force (side view)



Appendix 30: Measurement of draught force (A view from rear)



Appendix 31: Attaching a dynamometer to the towed tractor

Appendix 32: Determination of field capacity and fuel consumption



Appendix 33: Table A of farm tractors in Mvomero District

S No	Make/Model	Type	Power (hp)	Year Manuf.	Condition	Village
1	Ford 6640	2WD	76	1987	Good	
2	Ford 6610	2WD	72	1987	Good	Turiani
3	Ford 7600	2WD	75	1984	Good	
4	Ford 6640	2WD	76	1987	Good	
5	Ford 5000	2WD	55	1984	Fair Good	Turiani
6	Fiat 70-66	2WD	69	1987	Fair Good	Turiani
7	Ford 6610	2WD	72	1987	Good	
8	Fiat 80-66	2WD	62	1988	Good	
9	Fiat 100-90	4WD	100	1989	Fair Good	Turiani
10	Ford 5000	2WD	55	1984	Poor	Turiani
11	Ford 6610	2WD	72	1987	Good	Turiani
12	MF 135	2WD	37	1979	Poor	
13	Ford 5000	2WD	55	1982	Poor	
14	Ford 5000	2WD	55	1984	Poor	Turiani
15	Fiat 76-66	2WD	69	1987	Good	
16	Fiat 100-90	4WD	100	1989	Fair good	Turiani
17	Fiat 70-66	2WD	69	1987	Good	
18	Fiat 70-66	2WD	69	1987	Good	
19	NH 80-665	4WD	120	1999	Good	
20	Ford 6610	2WD	72	1987	Good	Turiani
21	Ford 6610	2WD	72	1987	Good	
22	Ford 6610	2WD	72	1987	good	
23	Fiat 70-66	2WD	69	1987	Good	
24	Ford 5000	2WD	55	1984	Poor	Turiani
25	Ford 5000	2WD	55	1982	Scrap	Turiani
26	Fiat 70-66	2WD	69	1987	Good	
27	Ford TS 90	2WD	70	2000	Good	Turiani
28	Ford TS 90	2WD	70	2000	Good	
29	Ford 5000	2WD	55	1989	scrap	Turiani
30	IH 685	2WD	65	1982	Poor	Turiani
31	Ford 6610	2WD	72	1987	Fair good	Turiani
32	Fiat 70-66	2WD	69	1987	Fair good	Turiani
33	Fiat 70-66	2WD	69	1987	Fair good	Mlali
34	Fiat 70-66	2WD	69	1987	Fair good	
35	Fiat 70-66	2WD	69	1987	Good	Mlali
36	Fiat 70-66	2WD	69	1987	Good	Mlali
37	Fiat 70-66	2WD	69	1987	Good	Mlali
38	MF 390	2WD	67	1989	Good	
39	MF390	2WD	67	1989	Good	Turiani
40	MF 375	2WD	62	1990	Good	

Appendix 34: Table B of farm tractors in Mvomero District

SNo.	Make/Model	Type	Power (hp)	Year Manuf.	Condition	Village
41	MF 290	2WD	65	1988	Good	Turiani
42	Fiat 80-66	2WD	62	1987	Good	
43	Valmet 604	2WD	61	1989	Scrap	
44	J Deere 2130	2WD	66	1985	Scrap	Mvomero
45	J.Deere 2130	2WD	60	1985	Scrap	
46	Fiat 80-66	2WD	62	1987	Good	Mvomero
47	IH 684	2WD	66	1982	Fair Good	
48	IH 684	2WD	66	1982	Fair Good	
49	IH 684	2WD	66	1982	Fair Good	
50	IH 685	2WD	70	1982	Fair good	Mlali
51	MF135	2WD	37	1978	Fair Good	
52	IH 684	2WD	66	1982	Fair good	
53	Fiat 70-66	2WD	69	1987	Good	
54	Fiat 70-66	2WD	69	1987	Good	Mvomero
55	Ford 6610	2WD	70	1986	Good	
56	M F 2640	4WD	90	1989	good	
57	Fiat 70-66	2WD	69	1987	Good	
58	Fiat 70-66	2WD	69	1987	Good	Turriani
59	MF 165	2WD	52	1982	Good	
60	Ford 5000	2WD	55	1981	Fair Good	Turiani
61	Ford 5000	2WD	55	1981	Fair Good	Turiani
62	Ford 5000	2WD	55	1981	Fair good	Turiani
63	Valmet 602T	2WD	58	1979	Fair Good	Turiani
64	Valmet 604	2WD	61	1979	Fair good	Turiani
65	Ford 5000	2WD	55	1981	Fair good	
66	Ford 6610	2WD	70	1987	Good	Turiani
67	Ford 5000	2WD	55	1981	Fair Good	Turiani
68	Ford 6600	2WD	70	1987	Good	
69	MF 375	2WD	62	1999	Good	Turiani
70	Ford 6610	2WD	70	1987	Good	Turiani
71	Valmet 604	2WD	61	1979	Fair good	
72	Valmet 604	2WD	61	1979	Fair good	Mvomero
73	Valmet 602	2WD	58	1979	Poor	Turiani
74	Ford 6600	2WD	70	1987	Fair good	Turiani
75	Fiat 70-66	2WD	69	1985	Good	Mvomero
76	Ford 6600	2WD	70	1987	Good	Turiani
77	Ford 7600	2WD	75	1987	Good	Turiani
78	Ford 6600	2WD	70	1987	Good	Turiani
79	Ford 6600	2WD	70	1987	Good	Turiani
80	MF290	2WD	65	1999	Good	
81	MF290	2WD	65	1999	Good	Mvomero

Appendix 35: Table C of farm tractors in Mvomero District

S. No	Make/Model	Type	Power (hp)	Year Manuf.	Condition	Village
82	J.Deere2130	2WD	66	1986	Good	Turiani
83	J.Deere2130	2WD	66	1986	Good	
84	Fiat 80-66	2WD	62	1987	Good	Mvomero
85	Fiat 70-66	2WD	69	1987	Good	
86	Valmet602	2WD	51	1979	Scrap	
87	C. Harvester	2WD		1998	Fair Good	
88	Fiat 70-66	2WD	69	1987	Good	Mvomero
89	Ford 5000	2WD	55	1981	Fair Good	Mvomero
90	J.Deere2130	2WD	66	1986	Fair Good	Mvomero
91	Fiat 70-66	2WD	69	1987	good	Turiani
92	Ford 5610	2WD	62	1988	Good	Turiani
93	Ford 5000	2WD	55	1984	Poor	Turiani
94	Ford 6600	2WD	70	1987	Good	Turiani
95	Ford 6600	2WD	70	1987	Good	Turiani
96	Ford 5000	2WD	55	1984	Poor	Turiani
97	Fiat 80-66	2WD	62	1987	Good	Turriani
98	Fiat 80-66	2WD	62	1987	Good	
99	Fiat 80-66	2WD	62	1988	Good	
100	Fiat 80-66	2WD	62	1988	Good	
101	Fiat 70-66	2WD	69	1987	Good	Turiani
102	Ford 5000	2WD	55	1984	Fair Good	Turiani
103	Fiat 6610	2WD	72	1987	good	
104	MF165	2WD	52	1979	Poor	Mvomero
105	Fiat 8066	2WD	62	1988	good	Turiani
106	Ford 5000	2WD	55	1982	Scrap	Turiani
107	Ford 6600	2WD	70	1986	Good	Turiani
108	Ford 6600	2WD	70	1986	Good	Turiani
109	Ford 5000	2WD	55	1987	Poor	Turiani
110	MF185	2WD	62	1979	Poor	Mvomero
111	Ford 5000	2WD	55	1984	Poor	Turiani
112	MF590	2WD	76	1997	good	Turiani
113	Valmet 604	2WD	61	1979	Scrap	Mvomero
114	Ford 5000	2WD	55	1982	Fair good	Turiani
115	Ford 4000	2WD	45	1982	Scrap	Turiani
116	Ford 5000	2WD	55	1983	Scrap	Mvomero
117	Ford 5000	2WD	55	1983	Poor	Mvomero
118	Ford 5000	2WD	55	1983	Fair Good	Turiani
119	Valmet 604	2WD	61	1979	Scrap	
120	Fiat 70-66	2WD	69	1987	Fair Good	Turiani
121	Fiat 70-66	2WD	69	1987	Poor	Turiani
122	Fiat 70-66	2WD	69	1987	poor	Mvomero

Appendix 36: Table D of farm tractors in Mvomero District

S.No	Make/Model	Type	Power (hp)	Year Manuf.	Condition	Village
123	Fiat 70-66	2WD	69	1987	Good	Mvomero
124	Ford 6610	2WD	72	1987	Good	Mvomero
125	Fiat 70-66	2WD	69	1987	Poor	Mvomero
126	Fiat 70-66	2WD	69	1987	poor	Turiani
127	Fiat 70-66	2WD	69	1987	Fair good	Turiani
128	Fiat 70-66	2WD	69	1987	Fair Good	Turiani
129	Fiat 70-66	2WD	69	1987	Poor	Mvomero
130	Fiat 70-66	2WD	69	1987	Poor	Turiani
131	Fiat 70-66	2WD	69	1987	Good	Mvomero
132	Fiat 70-66	2WD	69	1987	good	Turiani
133	Fiat 70-66	2WD	69	1987	Good	Mvomero
134	Fiat 70-66	2WD	69	1987	Good	Mvomero
135	Ford 6600	2WD	70	1989	Poor	Mvomero
136	Valmet 604	2WD	61	1979	Fair Good	Mvomero
137	Valment 604	2WD	61	1979	Scrap	Mvomero
138	Fordson Major	2WD		1972	Scrap	Mvomero
139	Fiat 70-66	2WD	69	1987	Good	Mvomero
140	Fiat 70-66	2WD	69	1987	Good	Mvomero
141	MF1178	2WD	52	1986	poor	Mvomero
142	Valmet 604	2WD	61	1979	Poor	Mvomero
143	Valmet 604	2WD	61	1979	Poor	Mvomero
144	Valmet 604	2WD	61	1979	Scrap	Mvomero
145	Fiat 80-66	2WD	62	1987	Good	Mvomero
146	Ford 4000	2WD	45	1981	Scrap	Mvomero
147	MF165	2WD	52	1978	Poor	Mvomero
148	Fiat 70-66	2WD	69	1987	Good	Mvomero
149	MF 275	2WD	67	1996	Good	Mvomero
150	Ford 6600	2WD	70	1987	Fair good	Mvomero
151	MF375	2WD	62	1999	Good	Mvomero
152	MF375	2WD	62	1999	Good	Mvomero
153	MF275	2WD	67	2000	Good	Mvomero
154	MF275	2WD	67	2001	Good	Mvomero
155	MF4240	4WD	90	2006	Good	Turiani
156	MF270	2WD	60	2006	Good	Turiani
157	MF375	2WD	62	2008	Good	Dihombo
158	CATIC	2WD	68	2006	Good	Mlali
159	MF375	2WD	62	2006	Good	Dakawa
160	MF240	2WD	42	2007	Good	Dakawa
161	CATIC	2WD	62	2007	Good	Dakawa
162	N.Holland	2WD	75	2008	Good	Dakawa
163	Bellarus	2WD	65	2008	Good	Dakawa

Appendix 37: Table E of farm tractors in Mvomero District

S.No	Make/ Model	Type	Power (hp)	Year Maf.	Status	Village
164	MF375	2WD	62	2008	Good	Dakawa
165	MF375	2WD	62	2008	Good	Dakawa
166	MF375	2WD	62	2007	Good	Dakawa
167	CATIC	2WD	68	2008	Good	Dakawa
168	MF375	2WD	62	2008	Good	Mlali
169	MF375	2WD	62	2009	Good	Dakawa
170	N. Holland	2WD	75	2009	Good	Wami Luhindo
171	CATIC	2WD	68	2009	Good	Doma
172	MF375	2WD	62	2009	Good	Mlali
173	CATIC	2WD	68	2009	Good	Doma
174	Kukje	P Tiller	15	2007	Good	Dakawa
175	Kukje	P Tiller	15	2001	Fair Good	
176	Kukje	P Tiller	15	2001	Fair Good	Mkindo
177	Kukje	P Tiller	15	2001	Fair Good	
178	Kukje	P Tiller	15	2002	Fair Good	Mgongola
179	Kukje	P Tiller	15	2002	Good	Turiani
180	Kukje	P Tiller	15	2002	Scrap	Mlali
181	kUkje	P Tiller	15	2001	Good	
182	Mitsubishi	P Tiller	15	2007	Good	Mkindo
183	Mitsubishi	P tiller	15	2009	Good	
184	Kukje	P Tiller	15	2004	Good	Dakawa
185	Kukje	P Tiller	15	2004	Good	Dakawa
186	Kukje	P Tiller	15	2004	Good	Dakawa
187	Kukje	P Tiller	15	2004	Good	Dakawa
188	Amec	P Tiller	15	2004	Good	
189	Kubota	P Tiller	15	2006	Good	Mkindo
190	Amec	P Tiller	15	2007	Good	Wami Luhindo
190	Amec	P Tiller	15	2007	Good	Mkindo
191	Mitsubishi	P Tiller	15	2009	Good	
192	Mitsubishi	P Tiller	15	2009	Good	
193	Mitsubishi	P Tiller	15	2009	Good	
194	Mitsubishi	P Tiller	15	2009	Good	Mkindo
195	Mitsubishi	P Tiller	15	2009	Good	
196	Mitsubishi	P Tiller	15	2009	Good	
197	Mitsubishi	P Tiller	15	2009	Good	
198	Mitsubishi	P Tiller	15	2009	Good	
199	Daedong	P Tiller	15	2009	Good	Turiani
200	Daedong	P Tiller	15	2009	Good	
201	Daedong	P Tiller	15	2009	Good	Dakawa
202	Daedong	P Tiller	15	2009	Good	Dakawa
203	Daedong	PTiller	15	2009	Good	Dakawa

Appendix 38: Table of Mechanization trends in Mvomero District

S/No.	Farm power	2005/06	2006/07	2007/08	2008/09	2009/10
1	Tractor	138	146	152	154	174
2	Power Tillers	-	6	9	12	30
3	Oxen	111	135	161	161	161
4	Donkeys	50	50	106	162	162

M D C (2009)

Appendix 39: Table of draught animals and equipment in Mvomero District

SN o.	Village	Oxen	Donkeys	Ploughs	Weeders	Ridgers	Traillers
1	W. Luhindo	3	4	10	2	1	1
2	Milama	44	18	9	2		4
3	Msufini	14		4			1
4	Dakawa	22	12	8			2
5	Hembeti	18	6	10	2	1	2
6	Kambala	12	12	2			2
7	Kipera	10	7	10	2		3
8	Mvomero	29	6	18	4	11	2
9	Mgete	-	97				60
	TOTAL	161	162	71	12	13	77

Source: MDC (2009)

Appendix 40: Table of farm power utilization pattern in Mvomero District

Total area (ha)	Cultivated (ha)	Area cultivated by			Number of		
		Tractors (ha)	Draught animals (ha)	Hand hoes (ha)	Tractor users	Draught animal users	Hand hoe users
732 500	247 219	494 43.8	247 21.9	1 730 53.3	8 587	63	51 097

Appendix 41: Table of disc plough specifications and price

ID	Mod	Wid	Dep	Plenth	PPrice	Age	Own	FCF	AnHrs	AnFC	RepairC	RepCHr	plwidth
No.	No.	(cm)	(cm)	(mm)	(Tshs)	(Yrs)	(Yrs)	(%)	(Hrs)	(Tshs.)	(Tshs.)	(Tshs.)	(mm)
1	ADP2	66	25	1115	4460000	2	10	11.15	150	497290	49729	331.53	1115
2	ADP3	99	25	2130	5060000	3	10	9.86	150	498916	49892	332.61	1265
3	ADP4	132	25	2520	5680000	6	10	6.81	150	386808	38681	257.87	1420
4	ADP5	165	25	2910	6080000	8	10	5.32	150	323456	32346	215.64	1520
5	1LY(SX)320	254	30	1165	4472000	4	10	8.71	150	389511	38951	259.67	1118
6	1LY(SX)325	75	30	2220	5100000	3	10	9.86	150	502860	50286	335.24	1275
7	1LY(SX)425	100	30	2528	5820000	1	10	54.61	150	3E+06	317830	2118.87	1455
8	1LY(SX)525	125	30	2940	6112000	2	10	11.15	150	681488	68149	454.33	1528
9	1LY(SX)625	150	30	2940	6112000	3	10	9.86	150	602643	60264	401.76	1528
10	1LQ_315	45	18	1160	4480000	5	10	7.70	150	344960	34496	229.97	1120
11	1LQ_320	60	20	2132	5120000	6	10	6.81	150	348672	34867	232.45	1280
12	1LQ_325	75	25	2540	5840000	7	10	6.02	150	351568	35157	234.38	1460
13	1LQ_426	100	25	2960	5860000	8	10	5.32	150	311752	31175	207.83	1465
14	1LQ_525	125	25	2980	5300000	10	10	4.16	150	220480	22048	146.99	1325
15	1LQ_530	150	30	1650	4600000	10	10	4.16	150	191360	19136	127.57	1150
16	1LYX_230	60	25	2300	5600000	9	10	4.70	150	263200	26320	175.47	1400
17	1LYX_330	90	25	2950	6920000	9	10	4.70	150	325240	32524	216.83	1730
18	1LYX_430	120	25	2210	4480000	4	10	8.71	150	390208	39021	260.14	1120
19	1LY(T)_325	75	30	2750	4960000	8	10	5.32	150	263872	26387	175.91	1240
20	1LY(T)_425	100	30	2340	5480000	7	10	6.02	150	329896	32990	219.93	1370
21	1LY(T)_525	125	30	2820	6000000	6	10	6.81	150	408600	40860	272.40	1500
22	1LY(T)_625	150	30	2940	6280000	9	10	4.70	150	295160	29516	196.77	1570

ID= Identity, Mod = Model, Wd = Width, Dep = Depth of cut, Plenth = length of plough, PPrice = Plough price, FCF= Fixed cost factor, AnHrs = Annual utilized hours, AnFC = Annual fixed cost, RepairC = Repair cost, RepCHr = Repair cost per hour, plwidth = Plough width

Appendix 42: Table of specifications and prices of twenty farm tractors

ID	Make	Mod	PTO	Price	Age	AH	OY	FCF	AFC	ARC	ATC	TCPH
No.	Type	No.	(kW)	(Tshs)	(Yrs)	(Hrs)	(Yrs)	(%)	(Tshs.)	(Tshs.)	(Tshs.)	(Tshs.)
1	MF	451	36	12600000	1	600	10	45.6	5745600	317520	6063120	10105.20
2	MF	471	48	16800000	2	600	10	28.3	4754400	423360	5177760	8629.60
3	MF	481	55	19250000	10	600	10	11.8	2271500	485100	2756600	4594.33
4	MF	491	59	20650000	3	600	10	22.2	4584300	520380	5104680	8507.80
5	MF	4260	70	24500000	9	600	10	12.5	3062500	617400	3679900	6133.17
6	MF	4370	75	26250000	10	600	10	11.8	3097500	661500	3759000	6265.00
7	N. H	T9050	331	115850000	1	600	10	45.6	52827600	2919420	55747020	92911.70
8	N. H	TG215	133	46550000	2	600	10	28.3	13173650	1173060	14346710	23911.18
9	N. H	TG245	152	53200000	3	600	10	22.2	11810400	1340640	13151040	21918.40
10	N. H	TG275	168	58800000	4	600	10	19.0	11172000	1481760	12653760	21089.60
11	N. H	TG305	192	67200000	5	600	10	16.9	11356800	1693440	13050240	21750.40
12	N. H	TN85DA	54	18900000	6	600	10	15.4	2910600	476280	3386880	5644.80
13	N. H	TN95DA	62	21700000	7	600	10	14.3	3103100	546840	3649940	6083.23
14	N. H	TV6070	80	28000000	10	600	10	11.8	3304000	705600	4009600	6682.67
15	FT	675DTC	50	17500000	6	600	10	15.4	2695000	441000	3136000	5226.67
16	JD	5103	33	11550000	4	600	10	19.0	2194500	291060	2485560	4142.60
17	JD	5105	30	10500000	5	600	10	16.9	1774500	264600	2039100	3398.50
18	JD	5105M	61	21350000	8	600	10	13.3	2839550	538020	3377570	5629.28
19	JD	5203	36	12600000	9	600	10	12.5	1575000	317520	1892520	3154.20
20	JD	5205	36	12600000	10	600	10	11.8	1486800	317520	1804320	3007.20

ID = Identity, Mod = Model, PTO = Power take off, OY = Ownership years, FCF = Fixed cost factor, AFC = Annual fixed cost, ARC = Annual repair cost, ATC = Annual Total cost, TCPH = Total cost per hour

Appendix 43: Table of annual fixed costs in percent of list price by machine category and age

Age (yrs)	Equipment Categories			
	1 Tractors	2 Combines S.P. Windrowers	3 Forage Harvester Balers, Blowers	4 Other Field Machine
1	45.57	51.19	57.92	54.61
2	11.01	11.85	10.37	11.15
3	10.13	10.49	9.18	9.86
4	9.32	9.28	8.12	8.71
5	8.57	8.22	7.19	7.70
6	7.89	7.27	6.36	6.81
7	7.26	6.43	5.63	6.02
8	6.68	5.69	4.98	5.32
9	6.14	5.04	4.41	4.70
10	5.65	4.46	3.90	4.16
11	5.20	3.95	3.45	3.68
12	4.78	3.49	3.06	3.25
13	4.40	3.09	2.71	2.87
14	4.05	2.74	2.39	2.54
15	3.72	2.42	2.12	2.24

(Interest rate is 8 percent and housing, etc. is 2 percent.)

Source: ASAE Standards (2006)